

**REF:100**

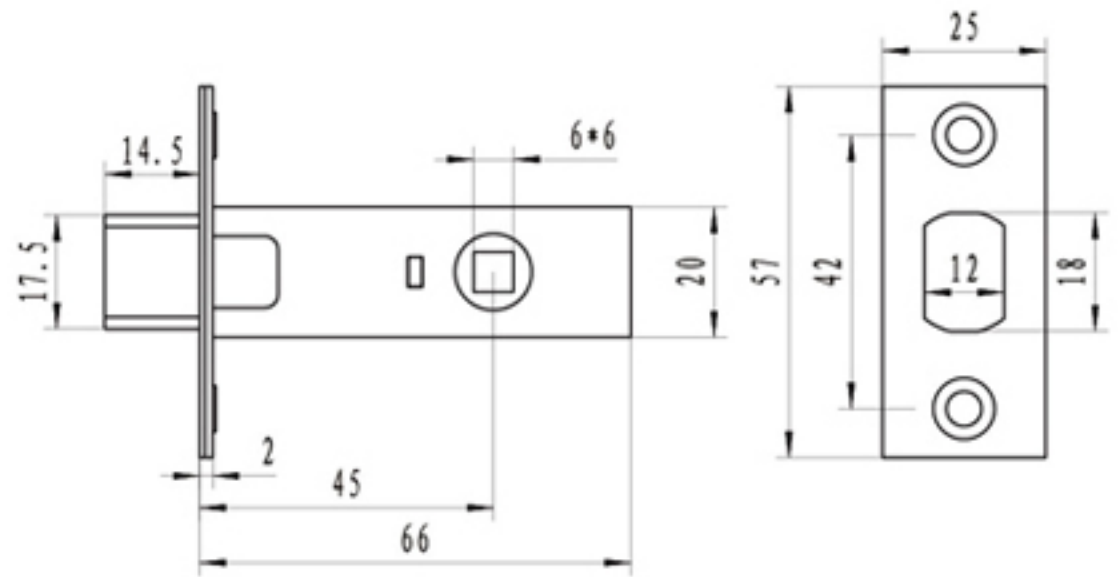

**REF:101**

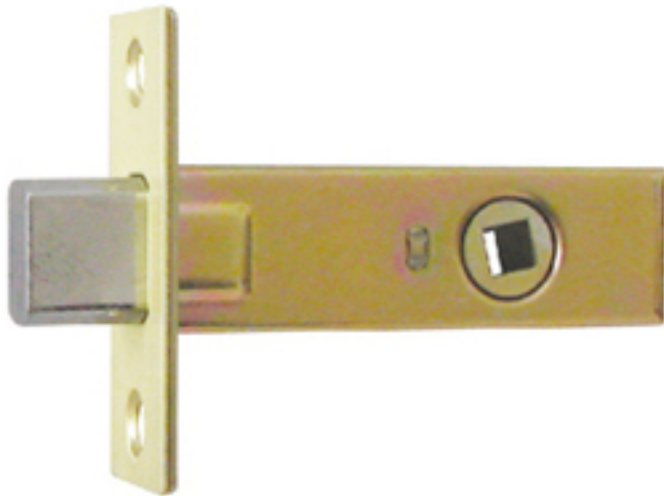
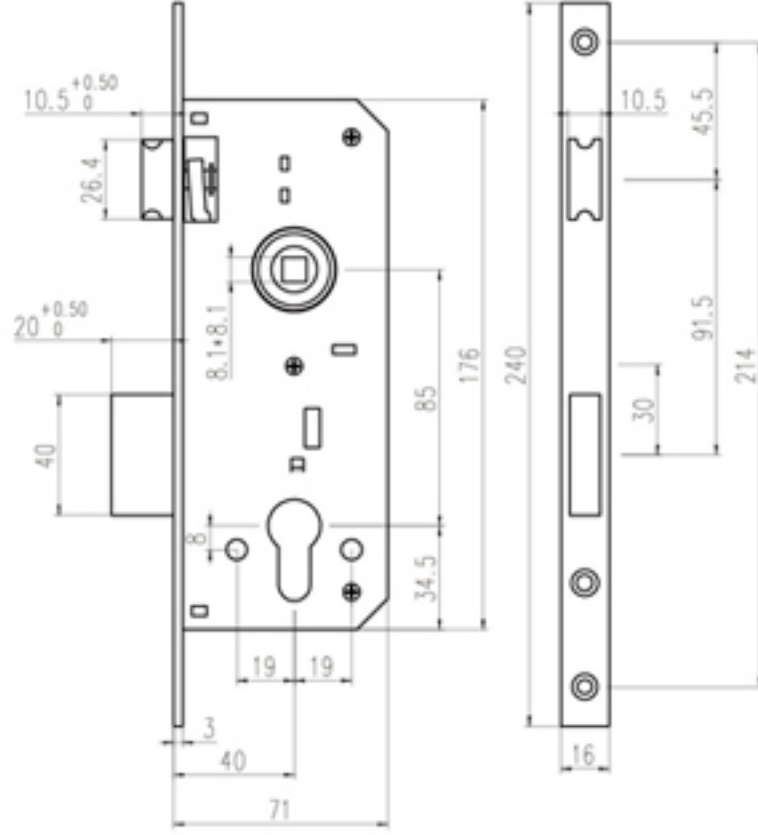

**REF:152R**

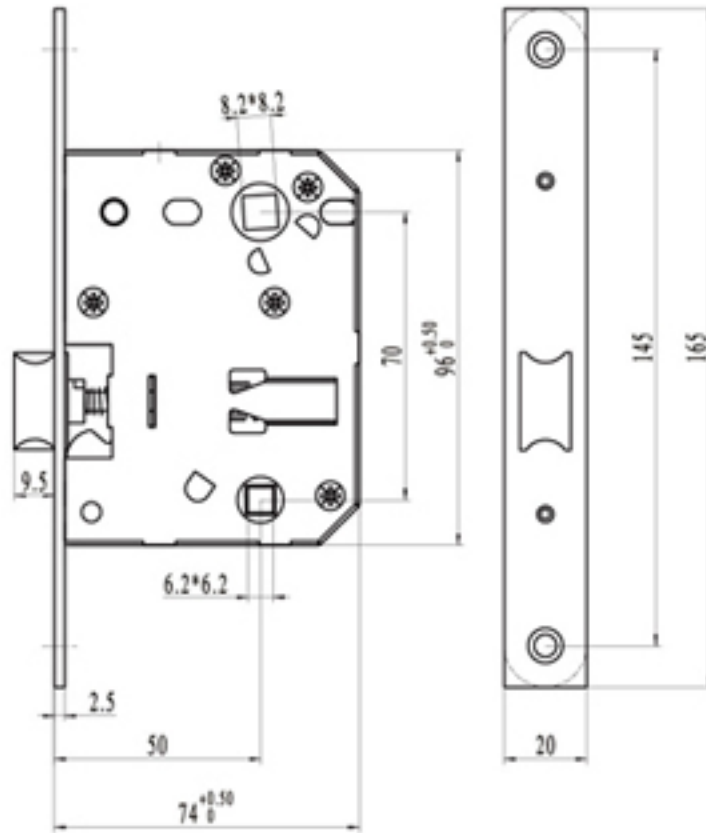

**REF:170**

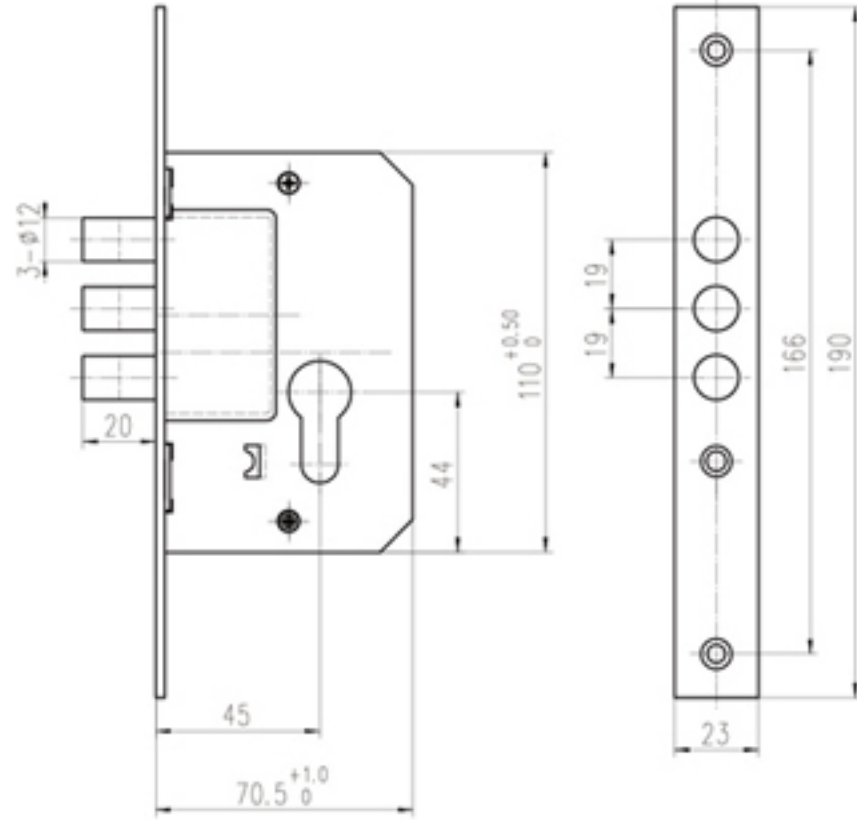

**REF:189-3A**

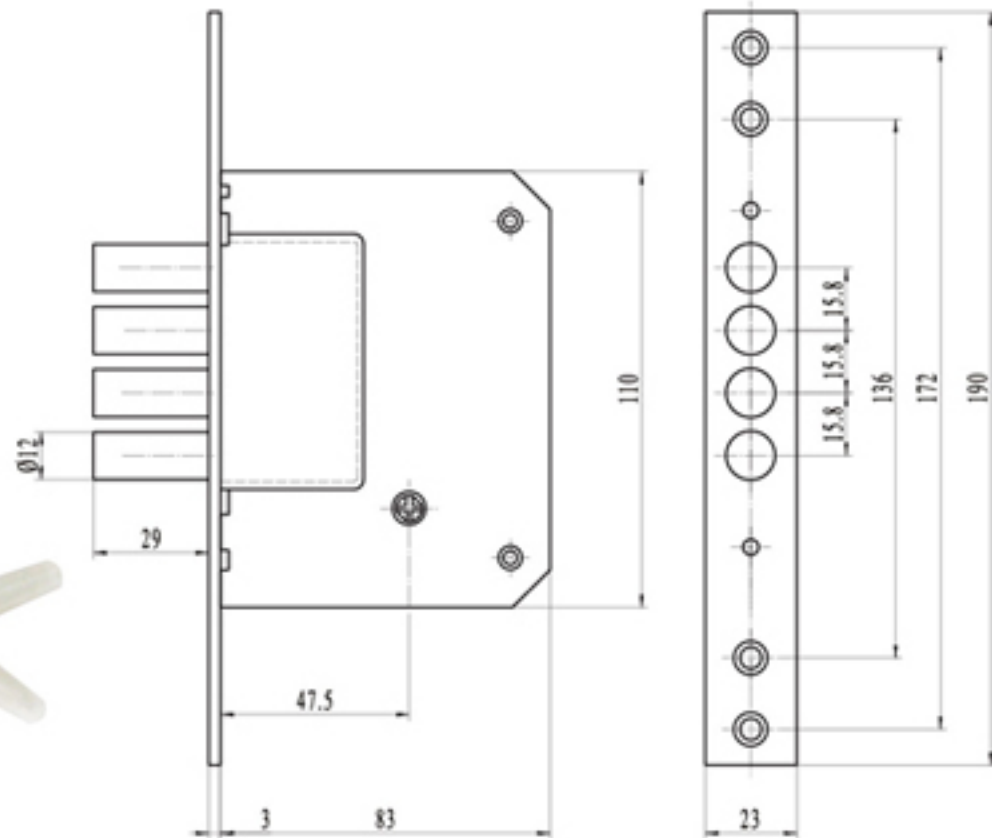
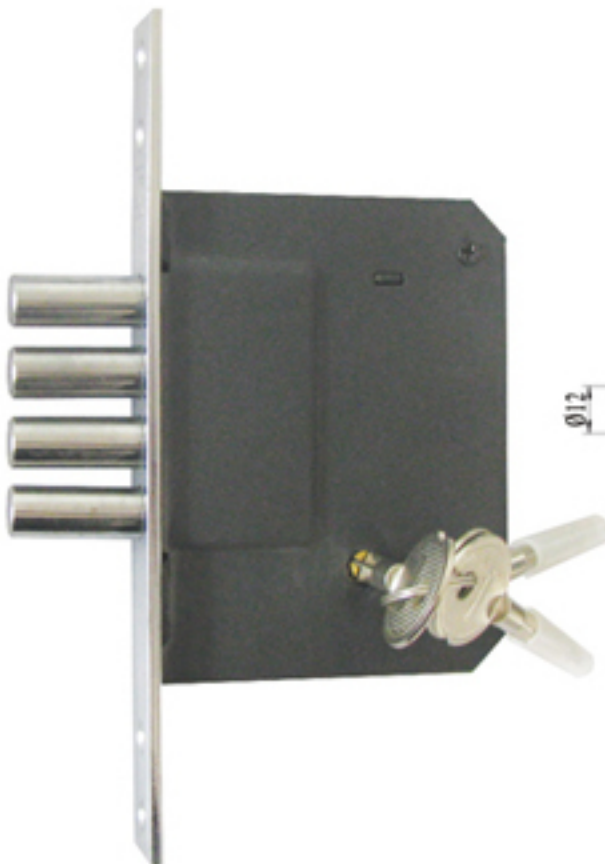

**REF:189-4**

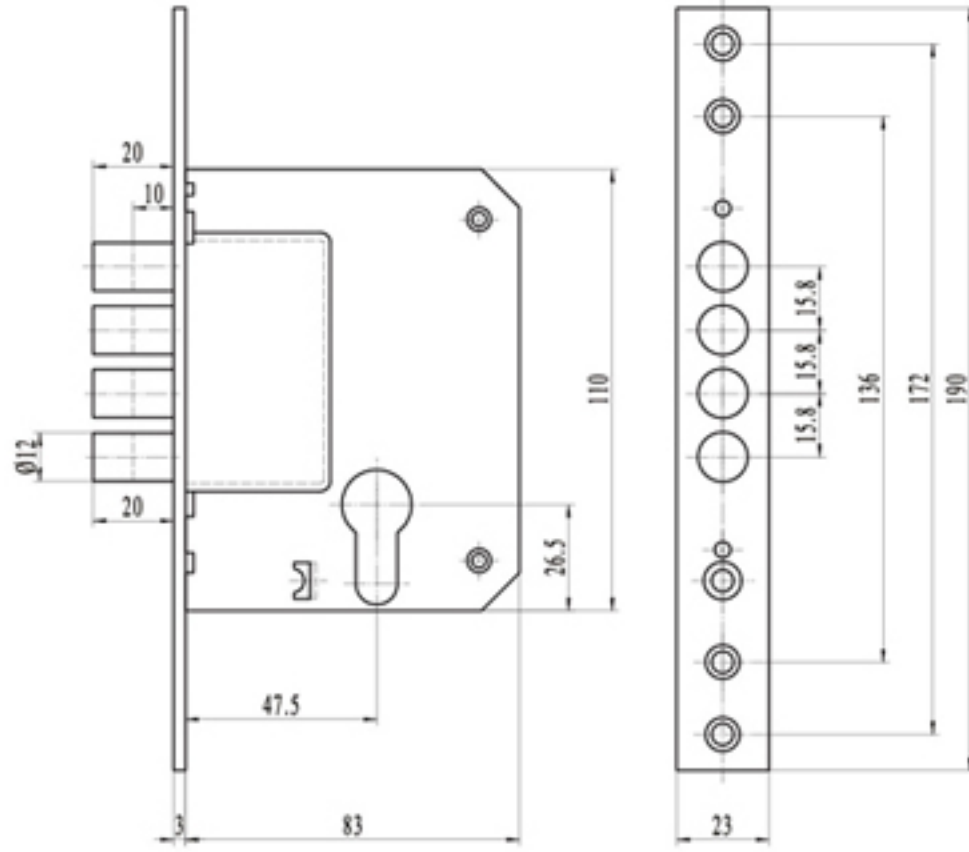

**REF:189-4A**

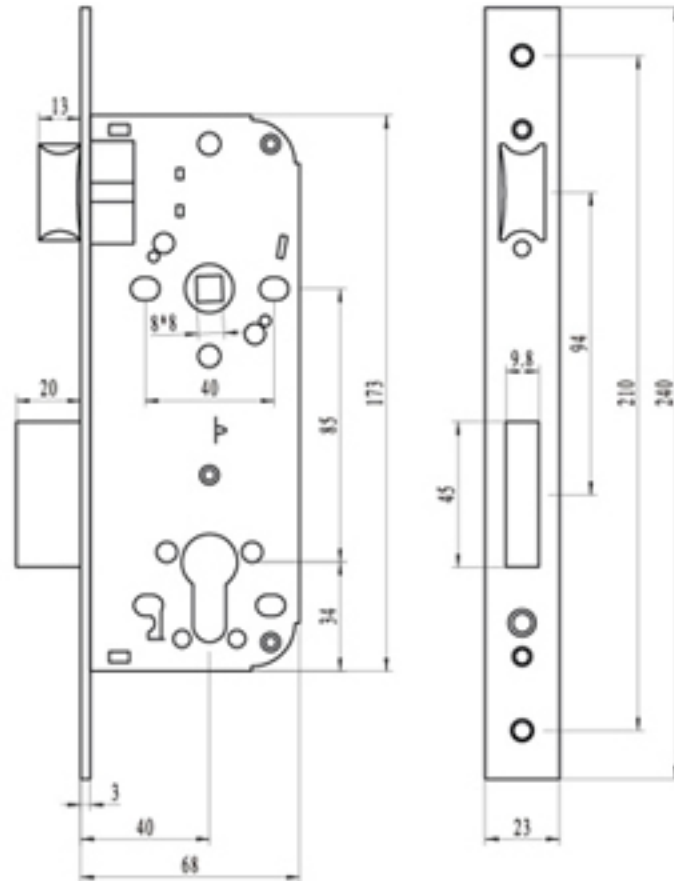

**REF:710**

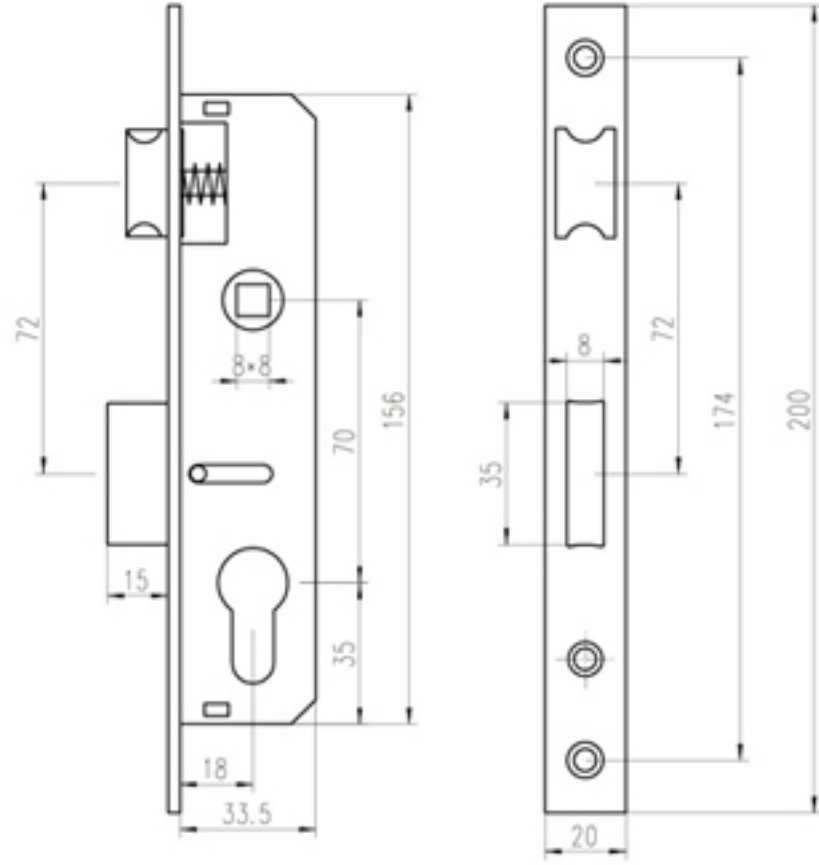

**REF:710S**

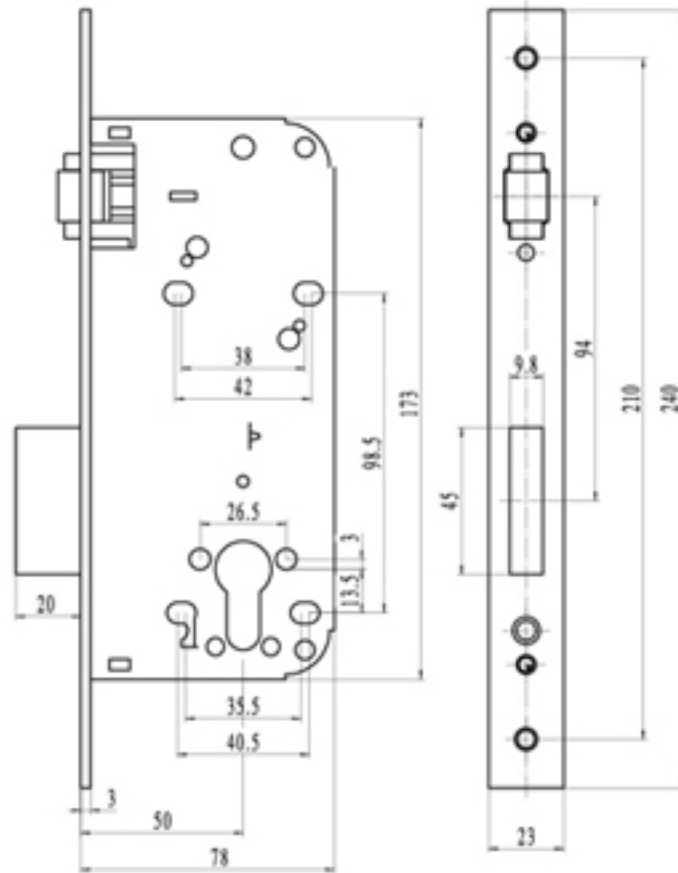

**REF:720**

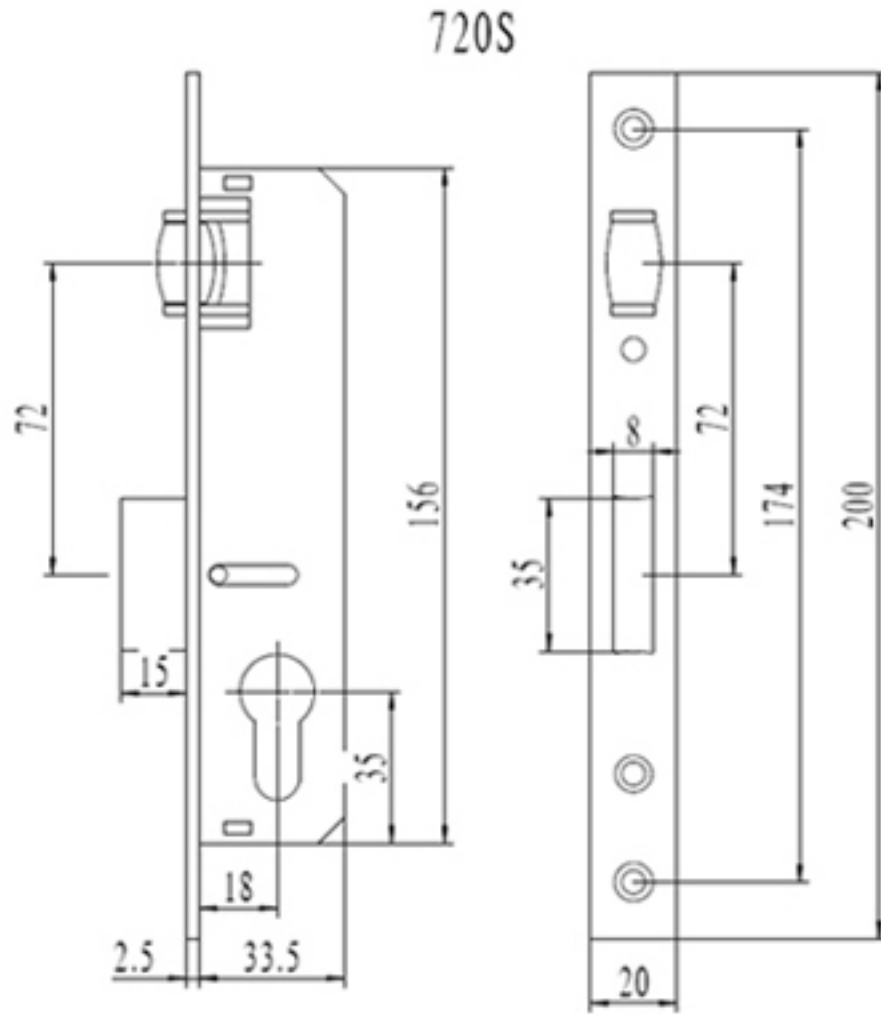

**REF:720S**

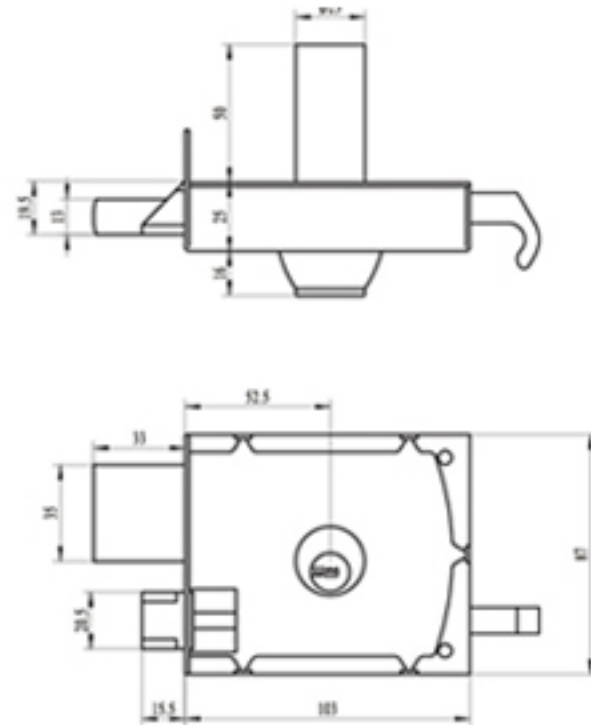

**REF:720W**

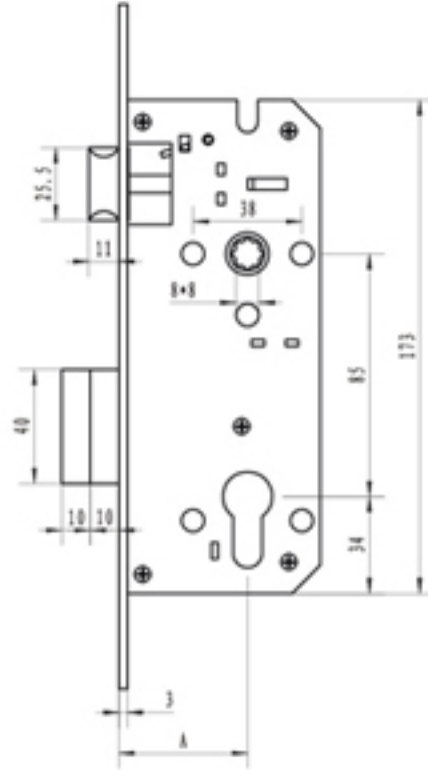

A1=40  
A2=45

**REF:745-1**

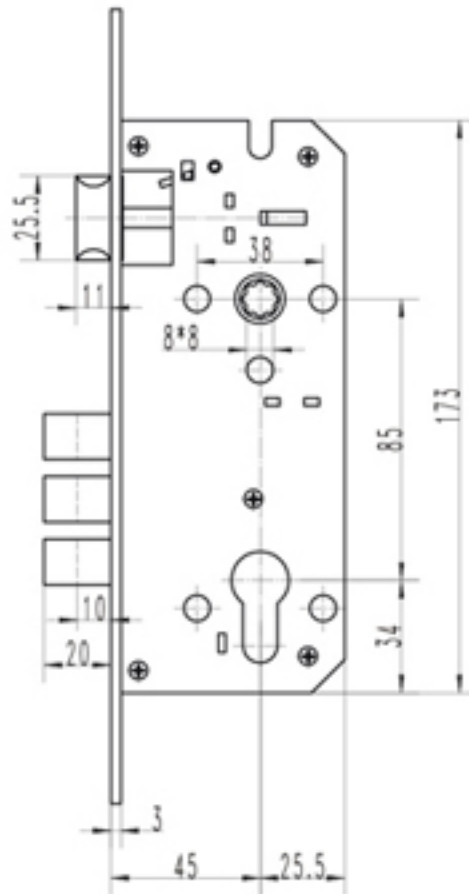

**REF:745-3**

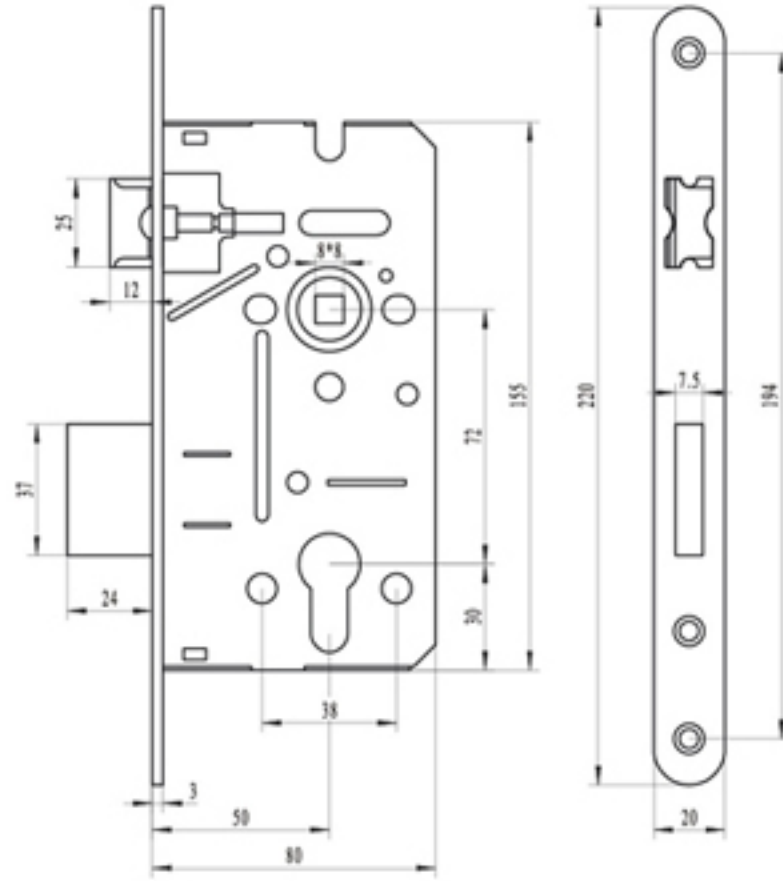
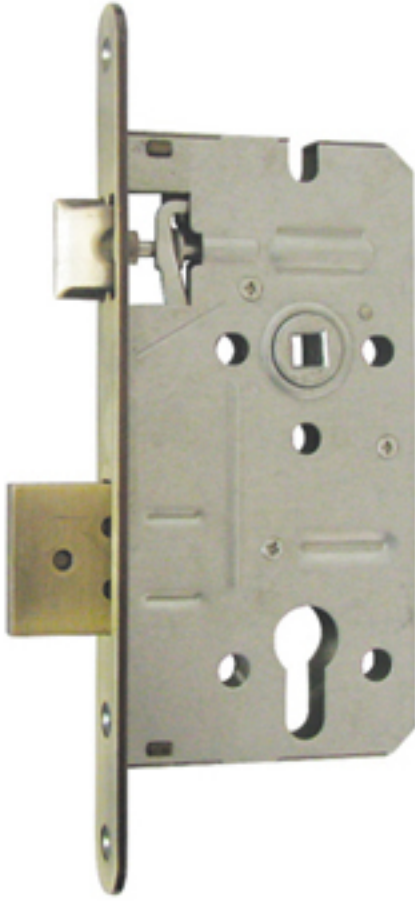

**REF:2279**

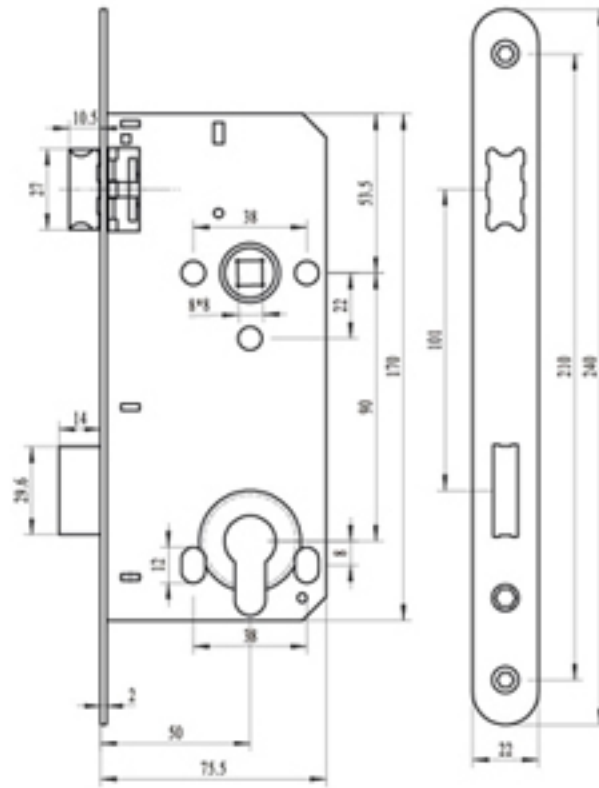

**REF:5090**



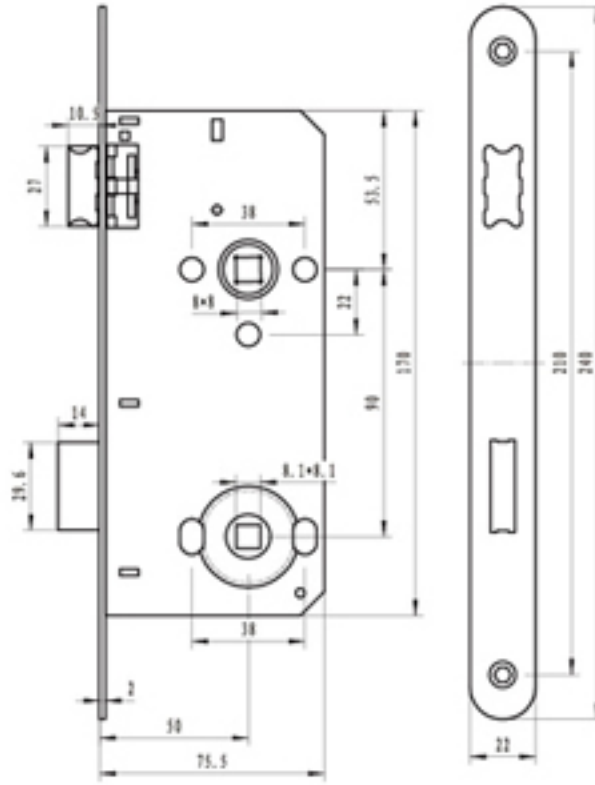

**REF:5090W**

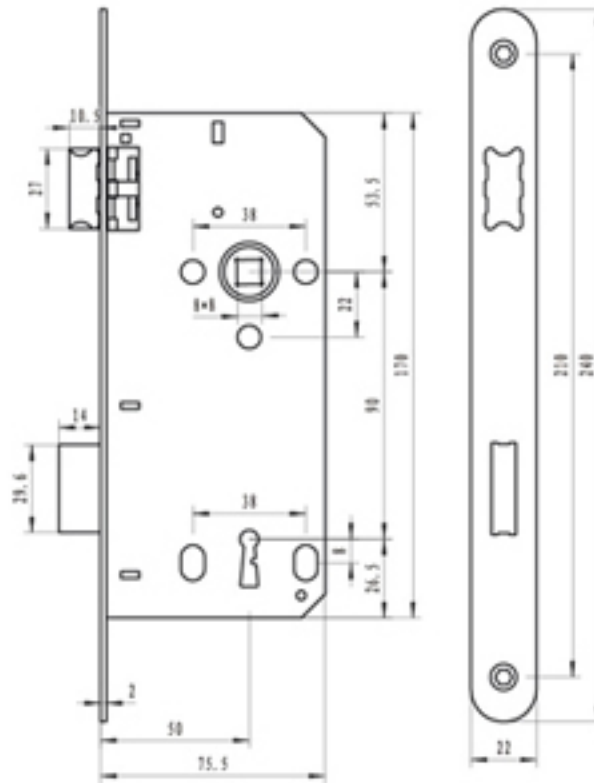

**REF:5090Y**

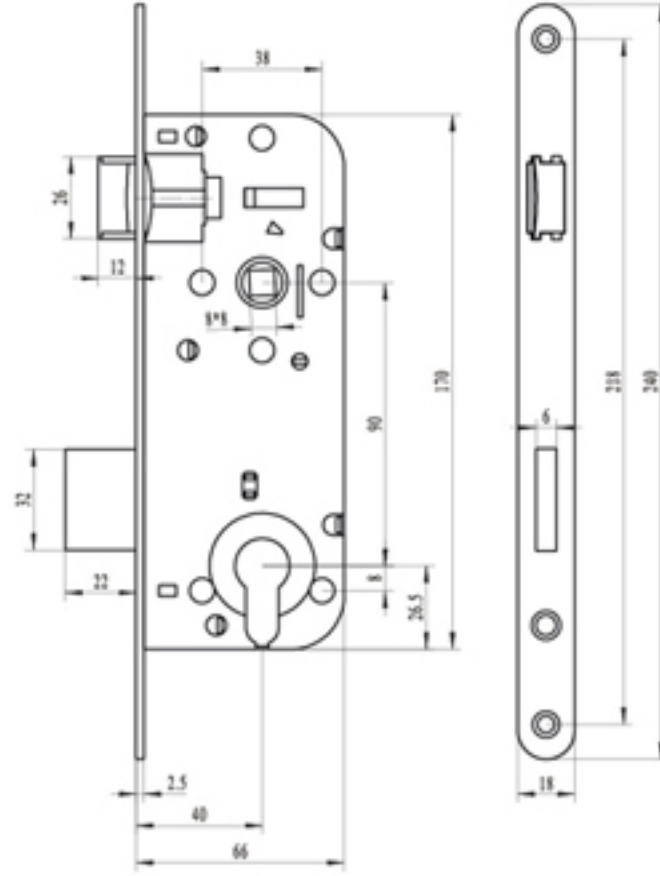

**REF:6540**

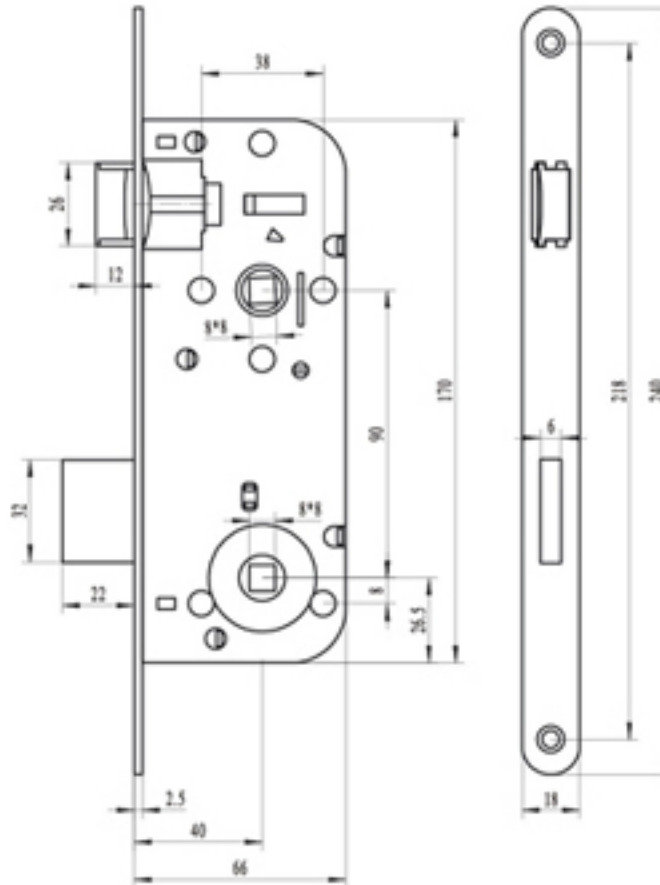

**REF:6540W**

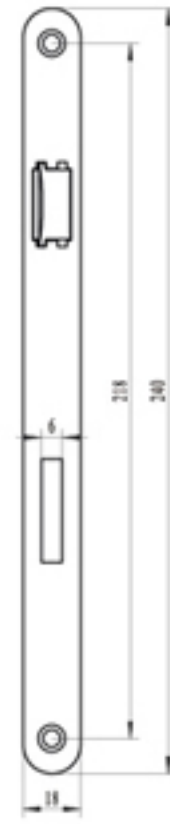
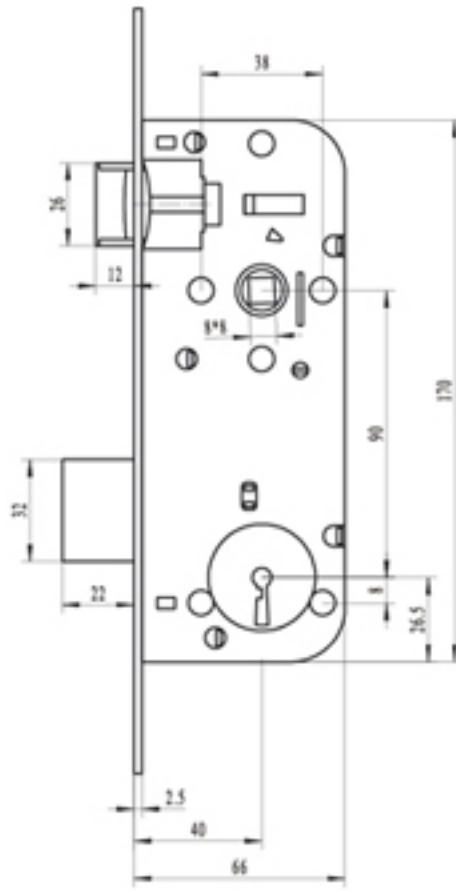

**REF:6540Y**

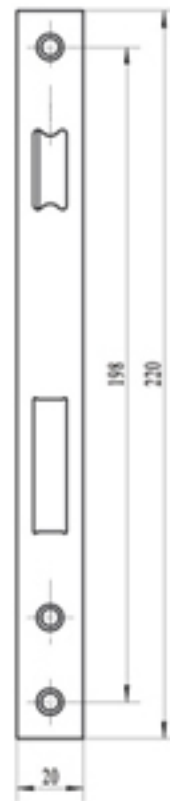
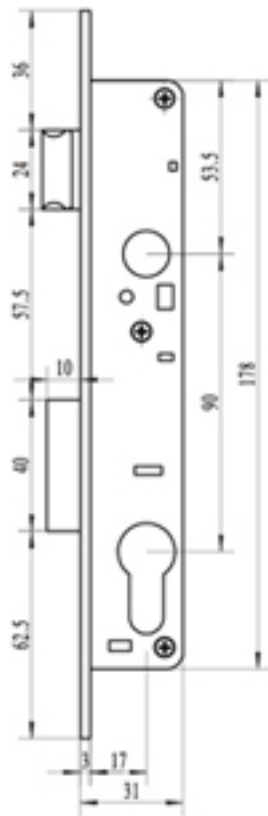

**REF:8520**

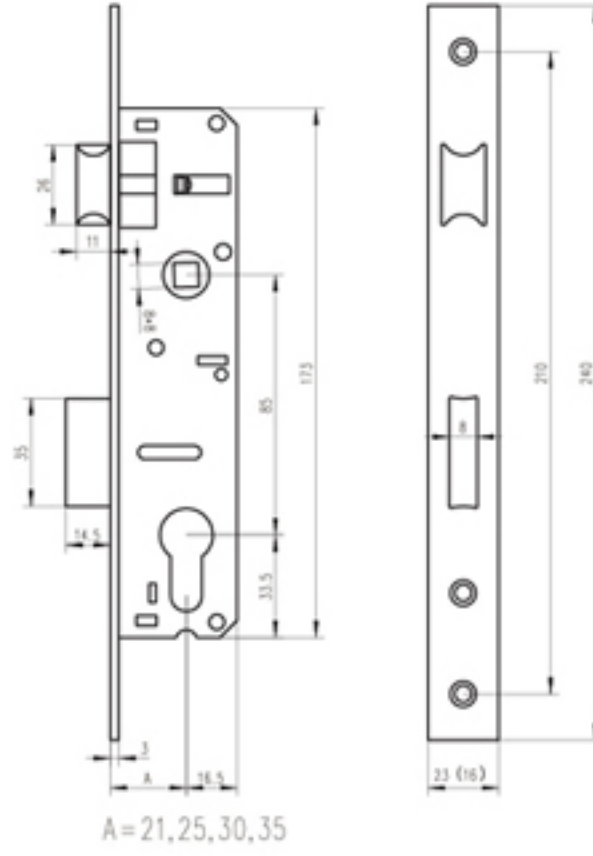

**REF:8805G**

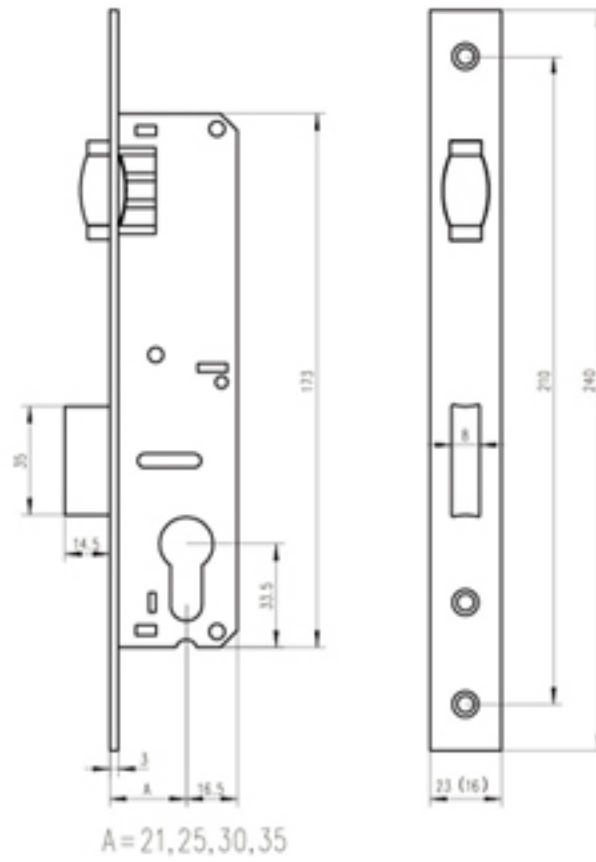

**REF:8805G-P**

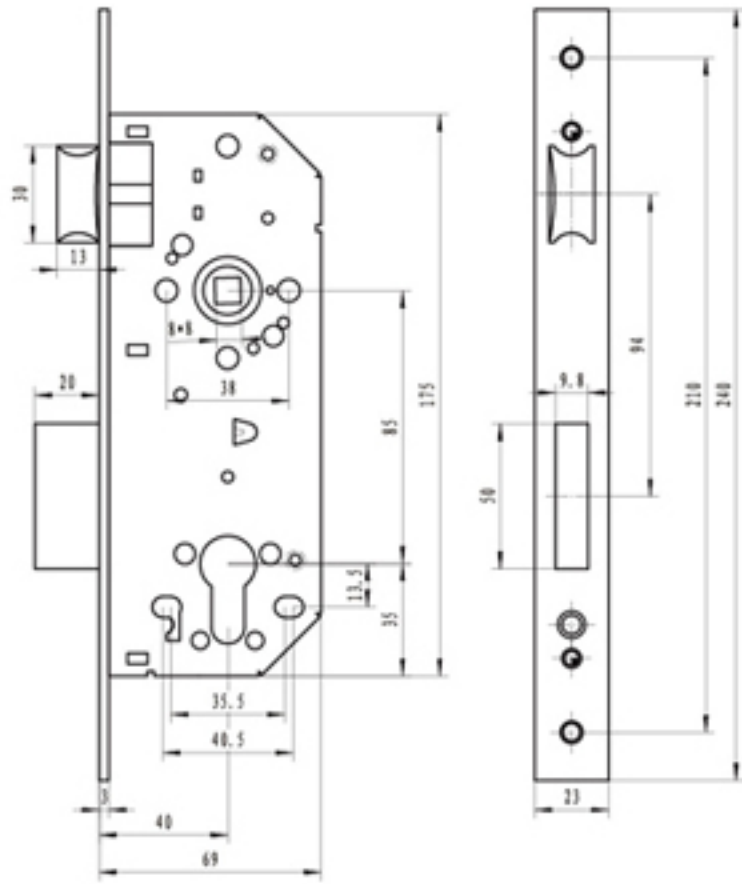

**REF:8811**

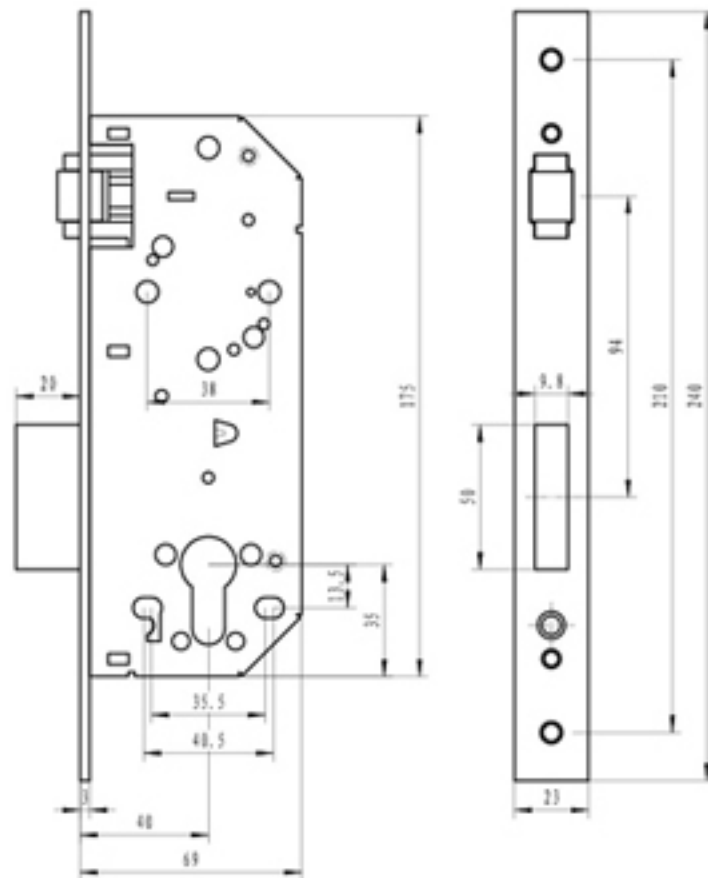

**REF:8812**

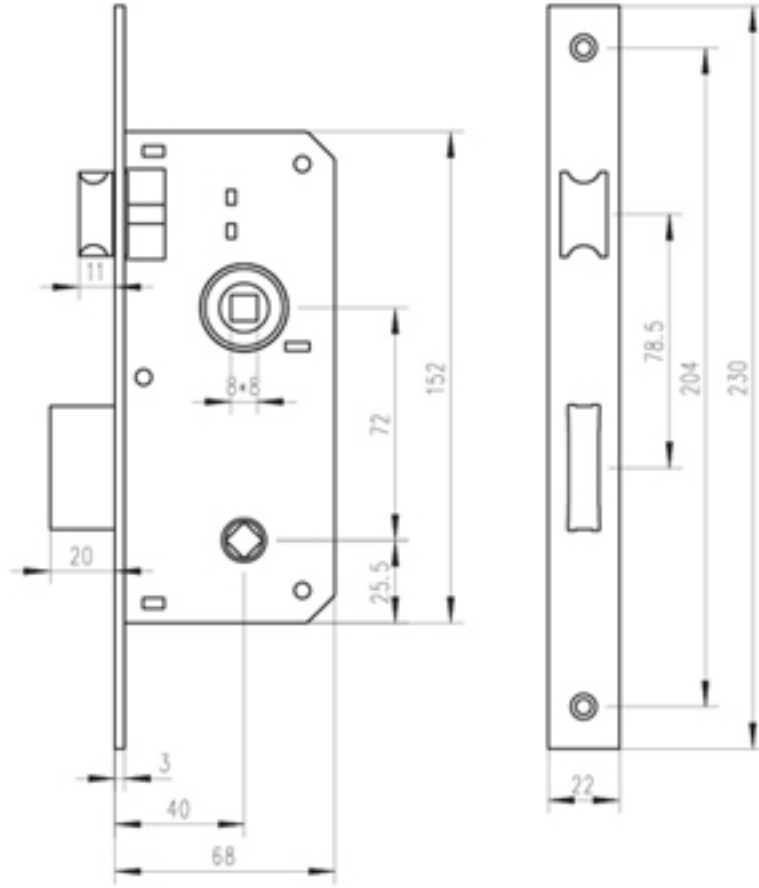

**REF:9010BB**

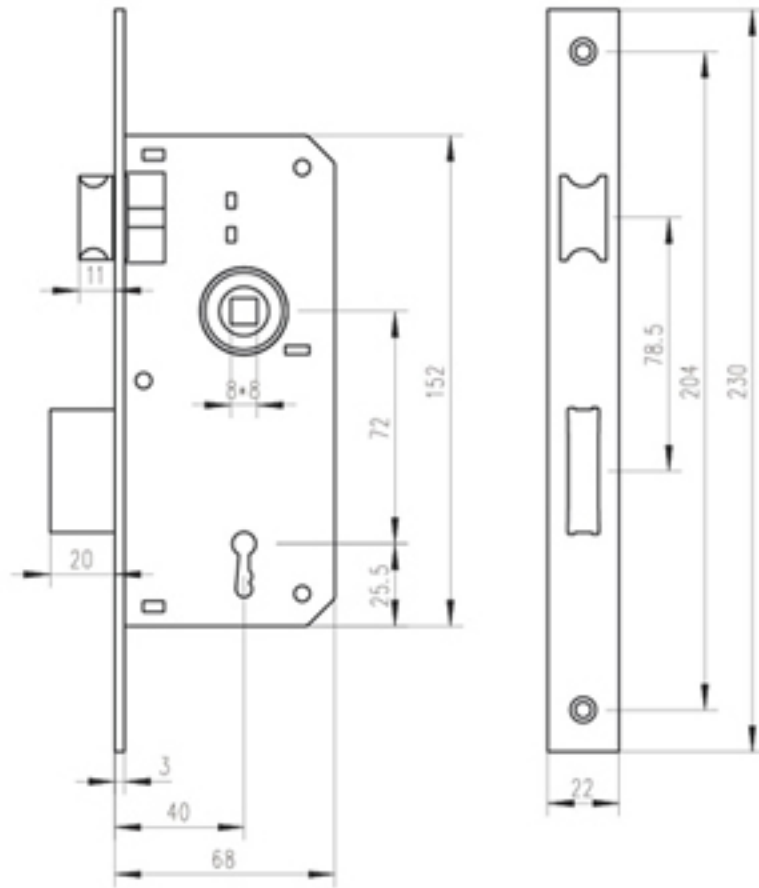

**REF:9010BK**

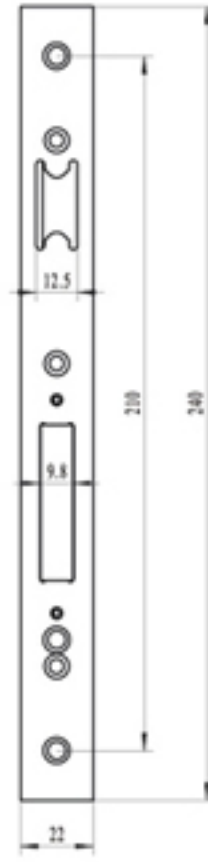
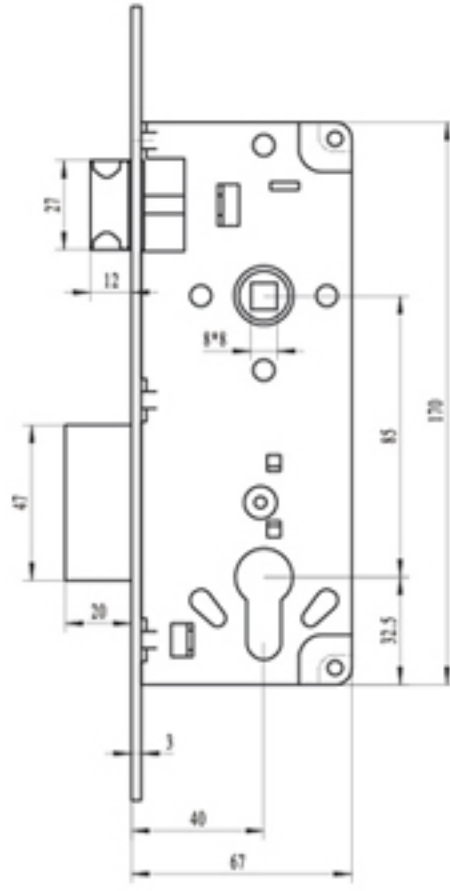

**REF:9011**

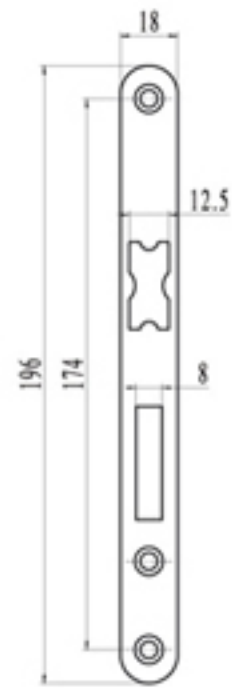
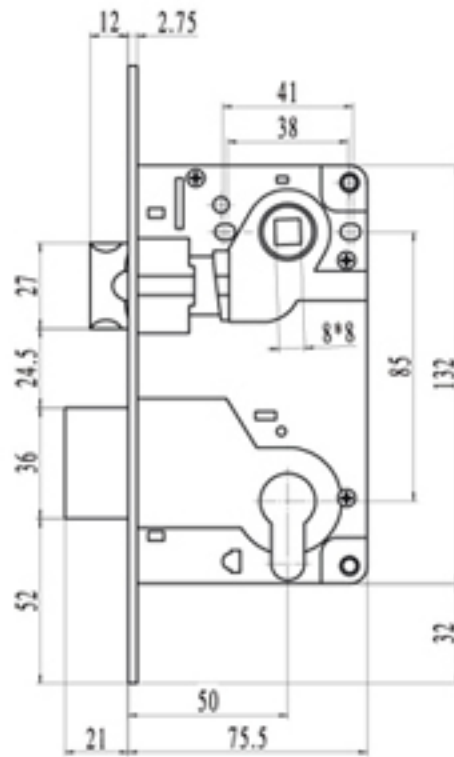

**REF:9171**

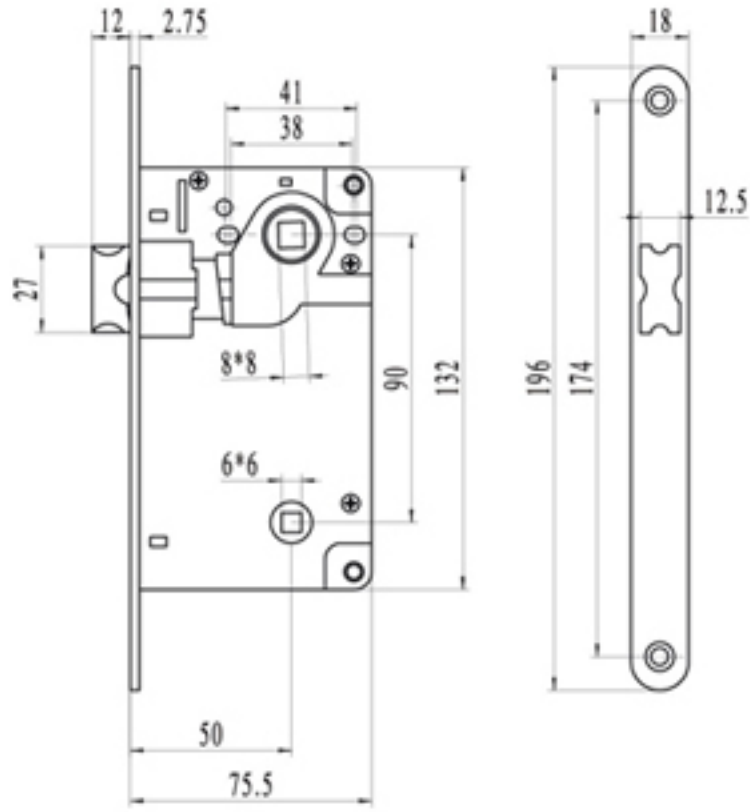

**REF:9171W**

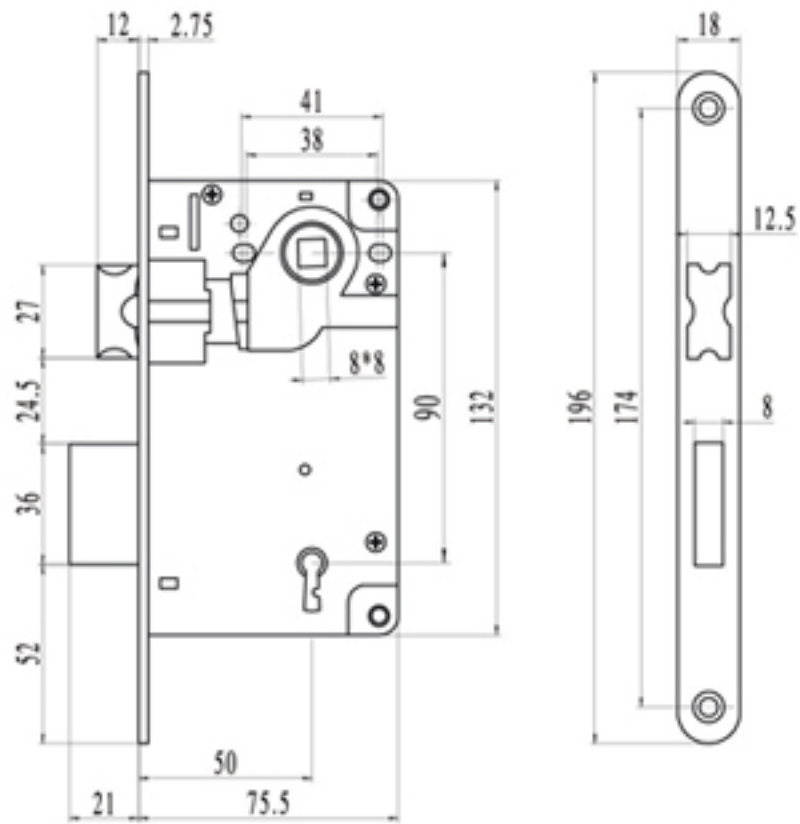
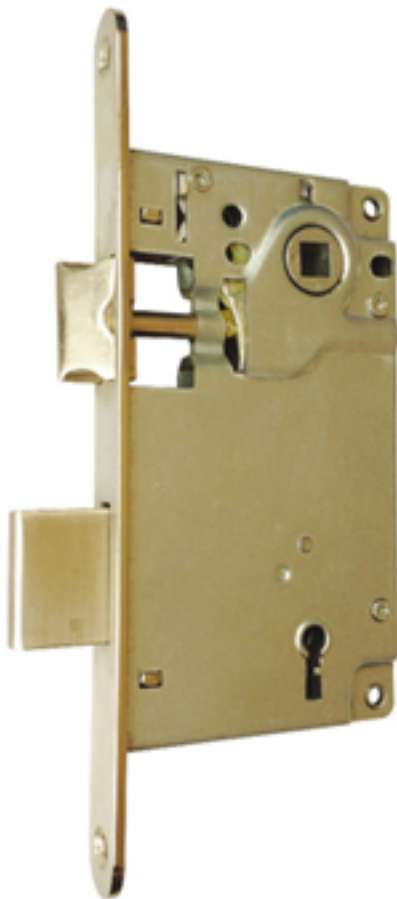

**REF:9171Y**



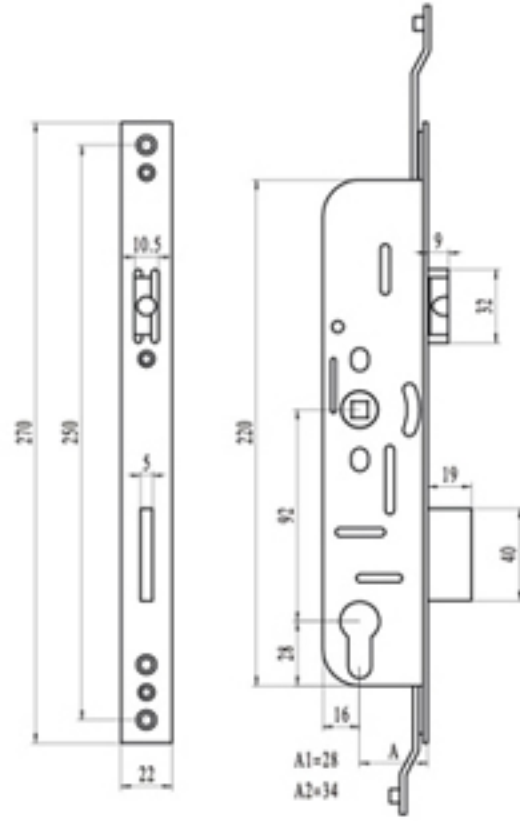

**REF:LDS**

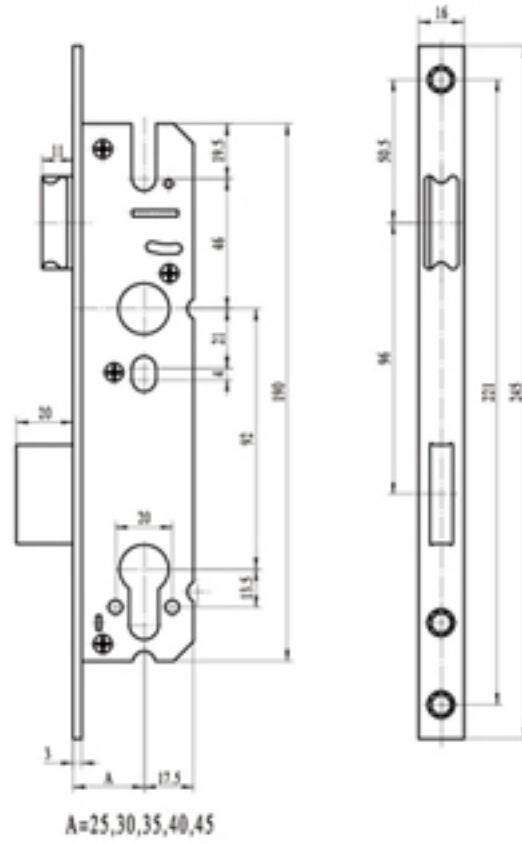

**REF:PVC**

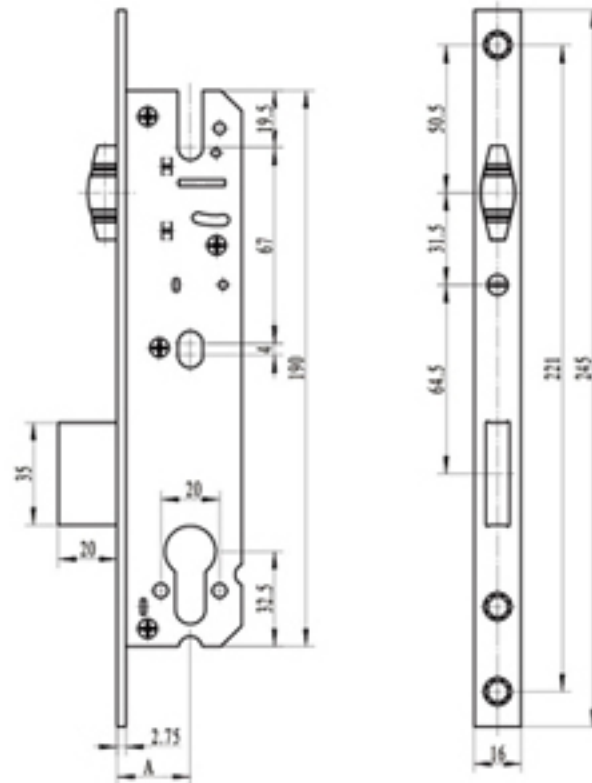

A=25, 30,35,40,45

**REF:PVC-P**

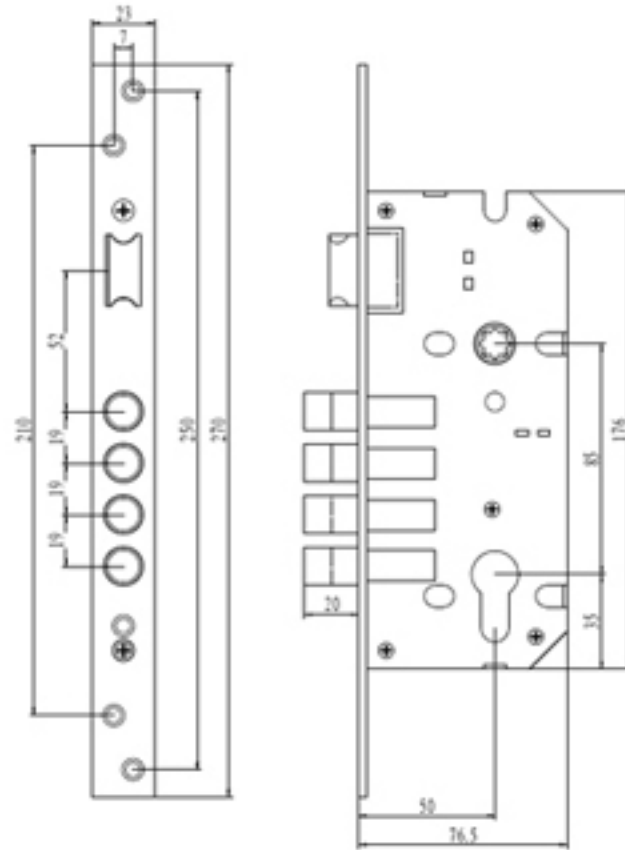

**REF 3201T**

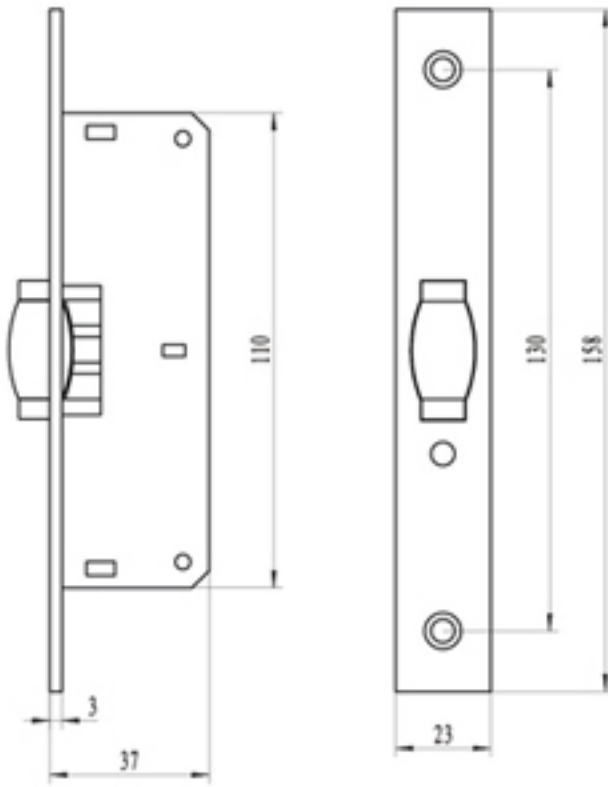

**REF:TDS**

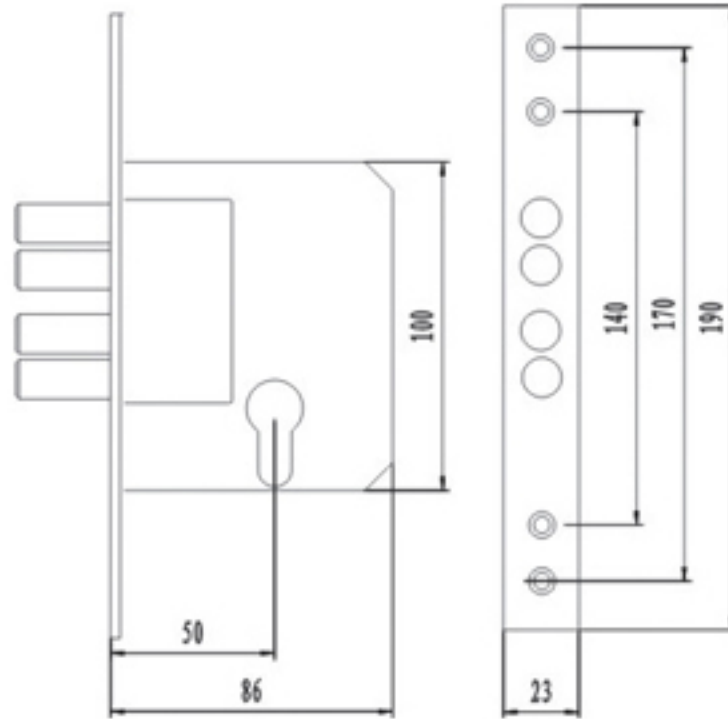

**REF 189-4A**

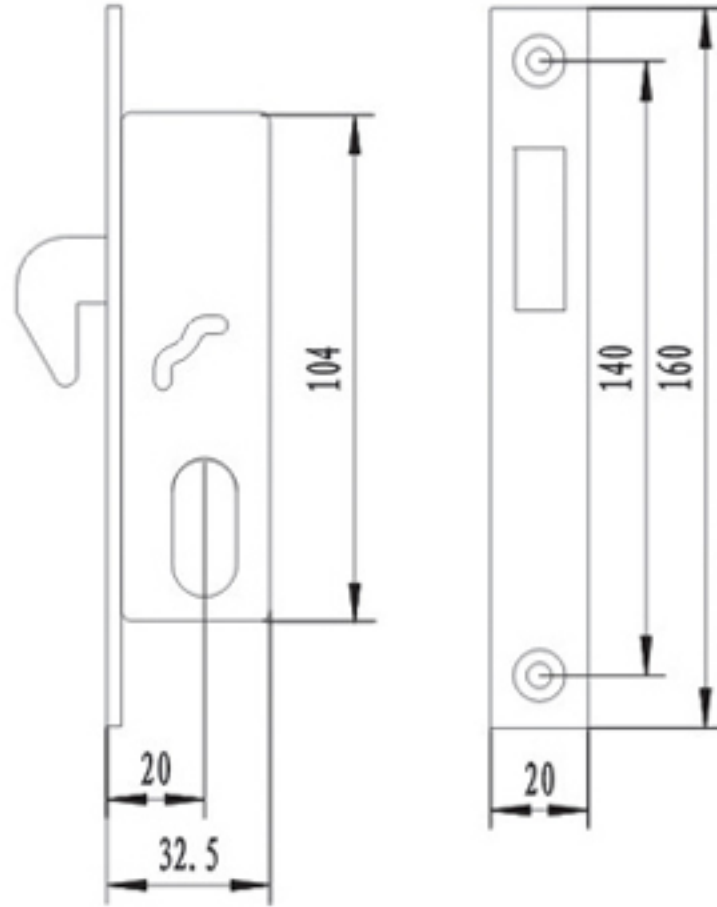

**REF 410SH**

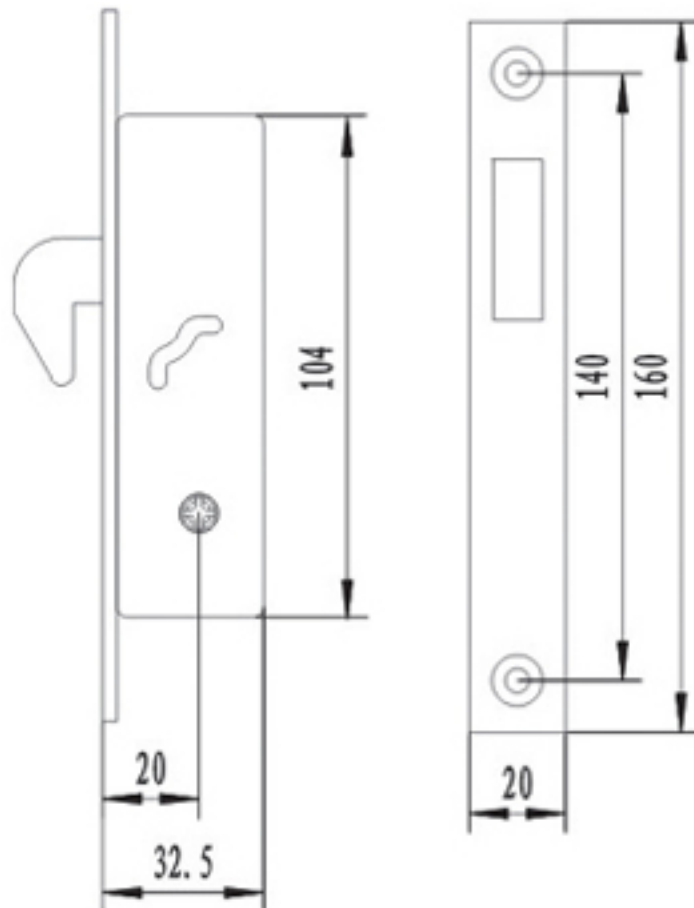

**REF 410SHO**

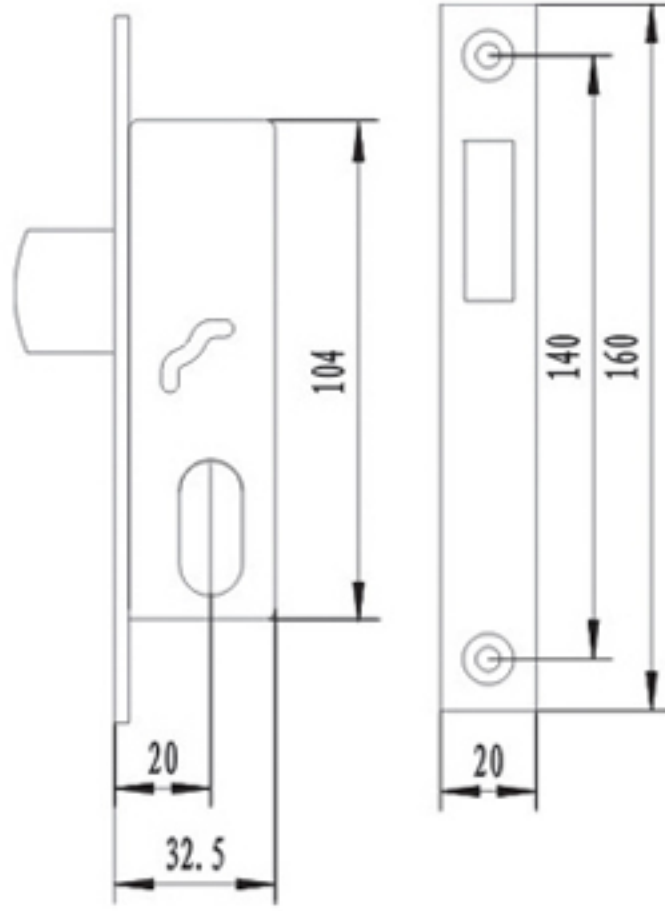

**REF 410SP**

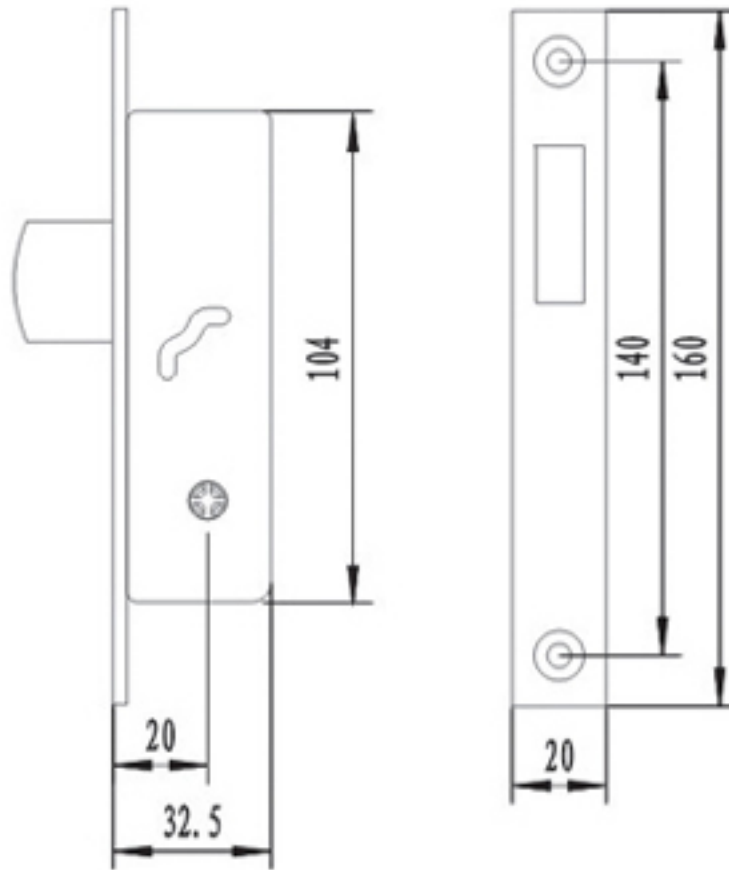

**REF 410SPO**

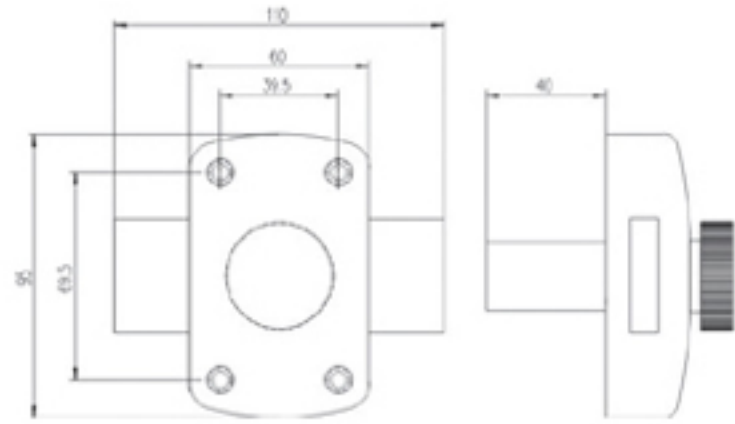

**REF 458**

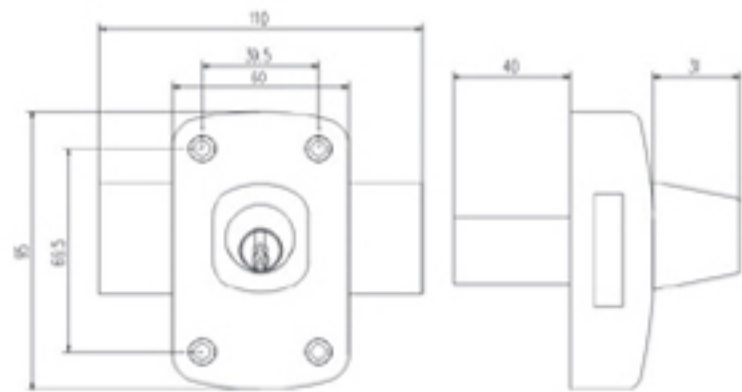

**REF 458D**

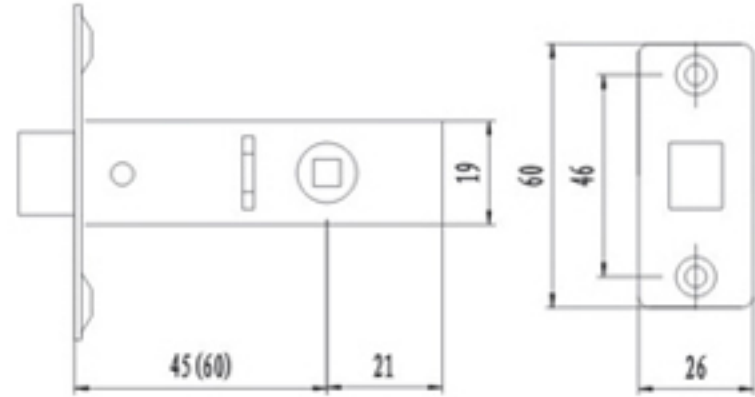

**REF 550**

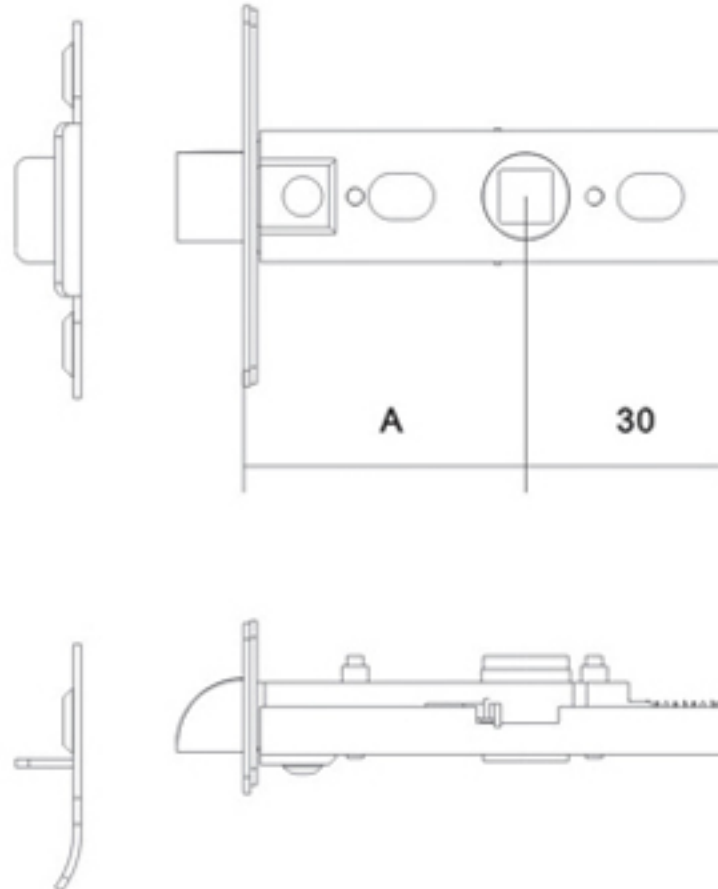

**REF 550E**

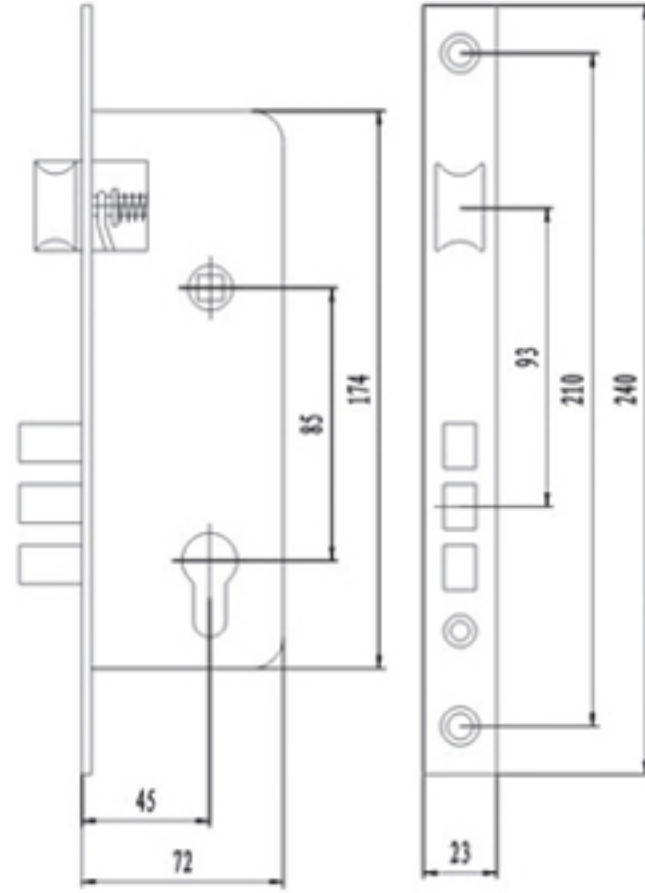

**REF 745-111F**

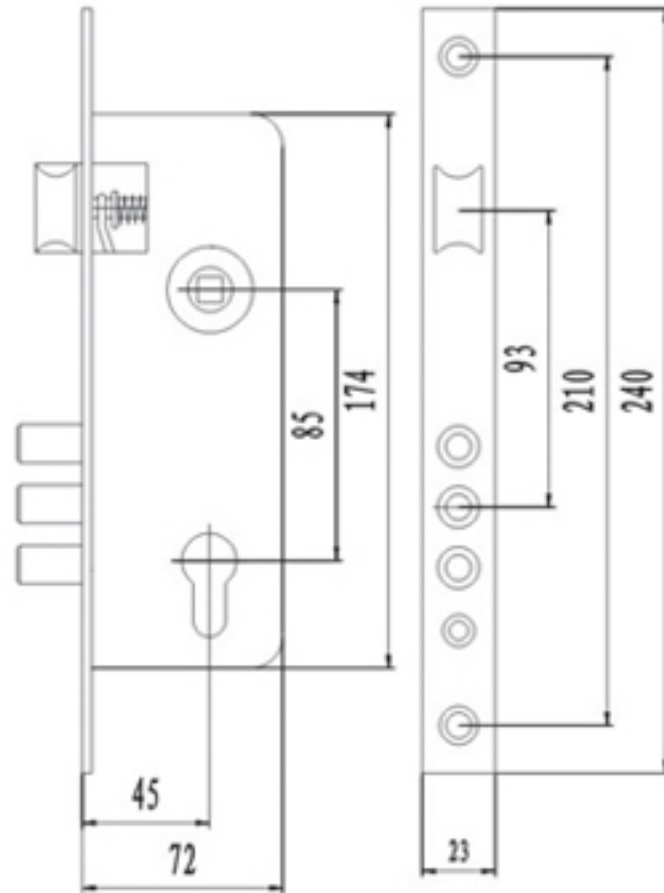

**REF 745-111R**



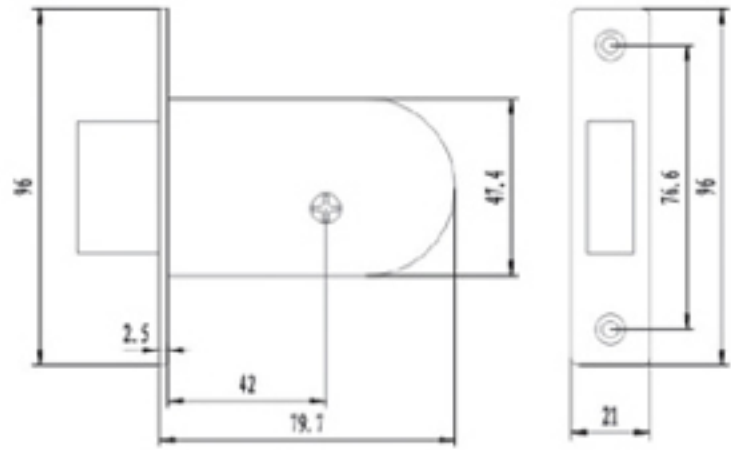

**REF 900A**

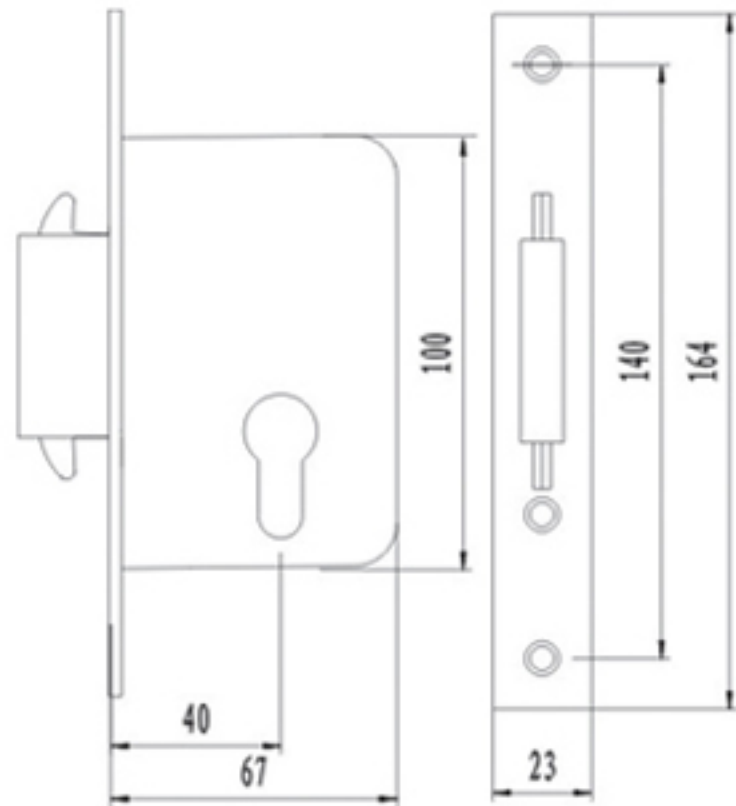

**REF 940A**

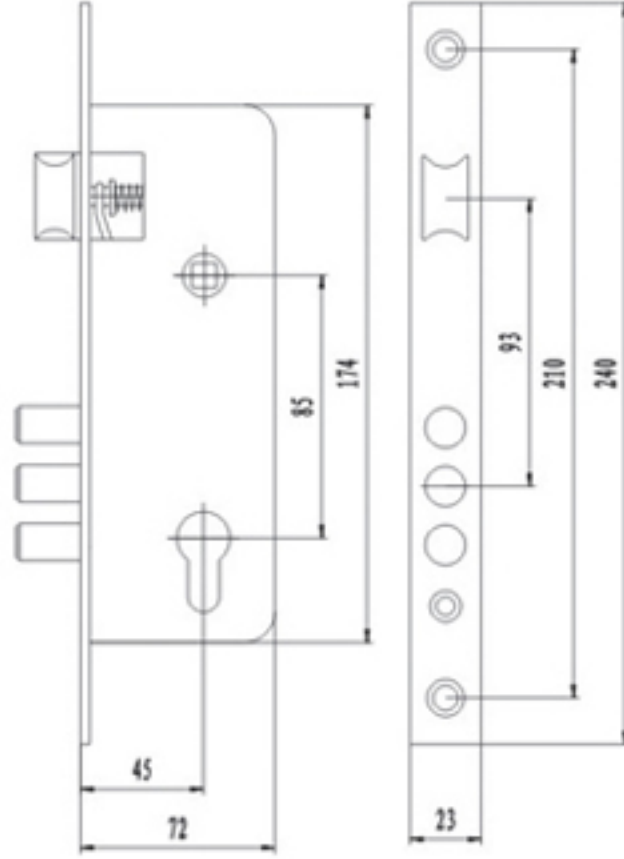

**REF 945-111**

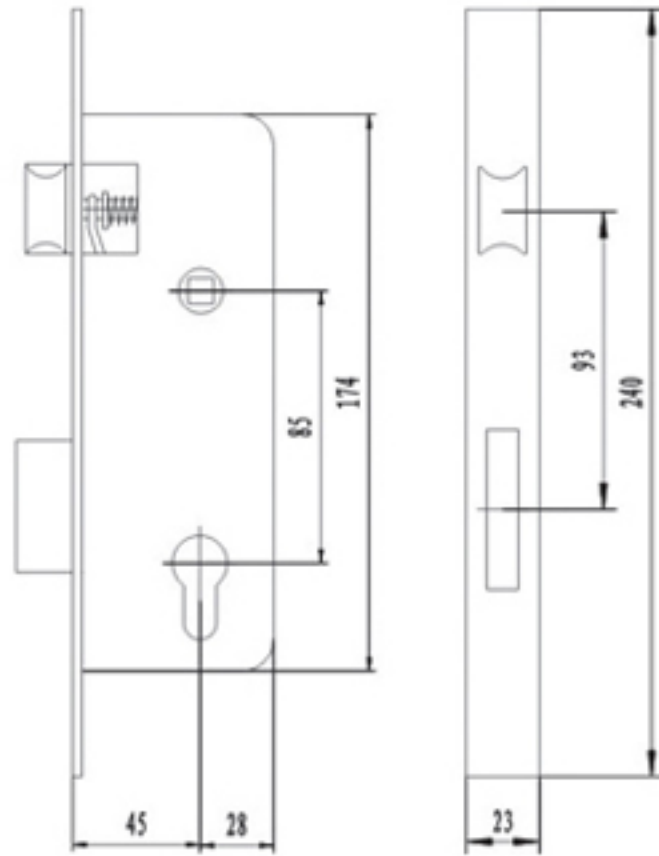

**REF 945R**

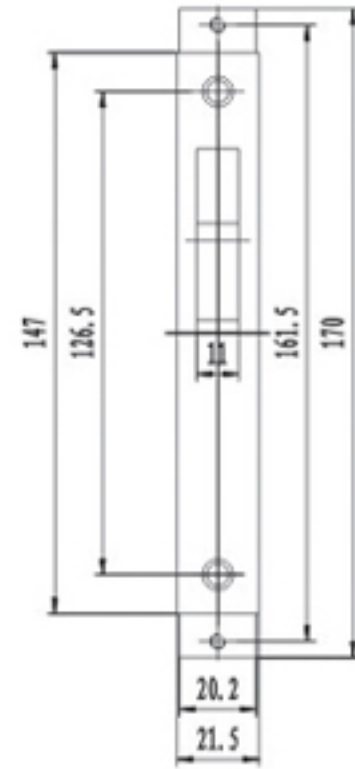
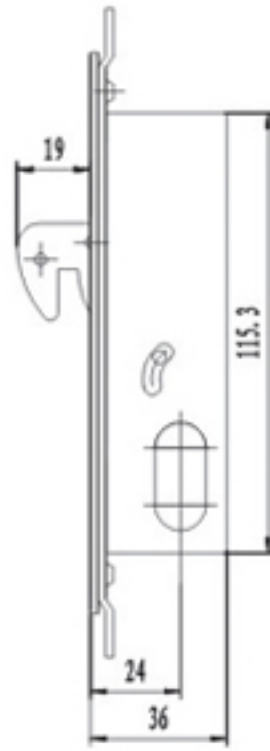

**REF 4123**

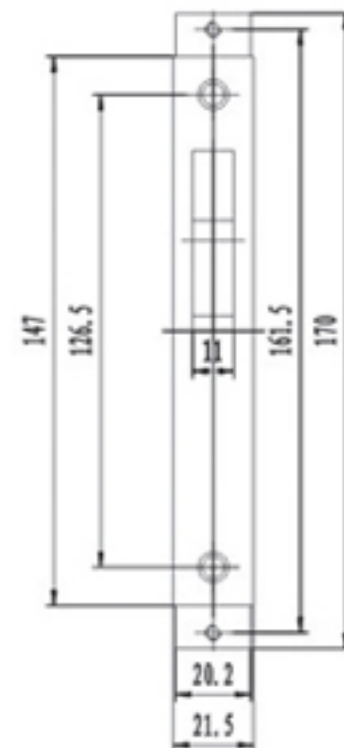
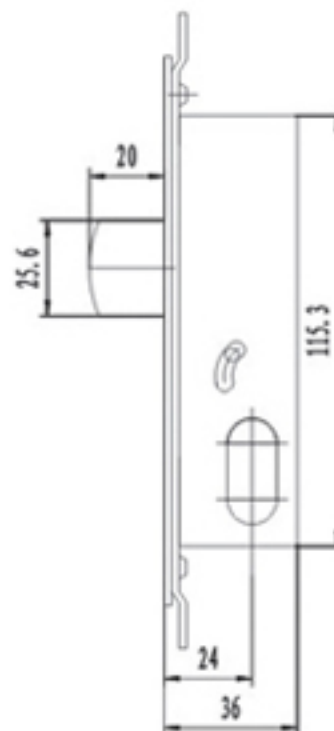

**REF 5123**

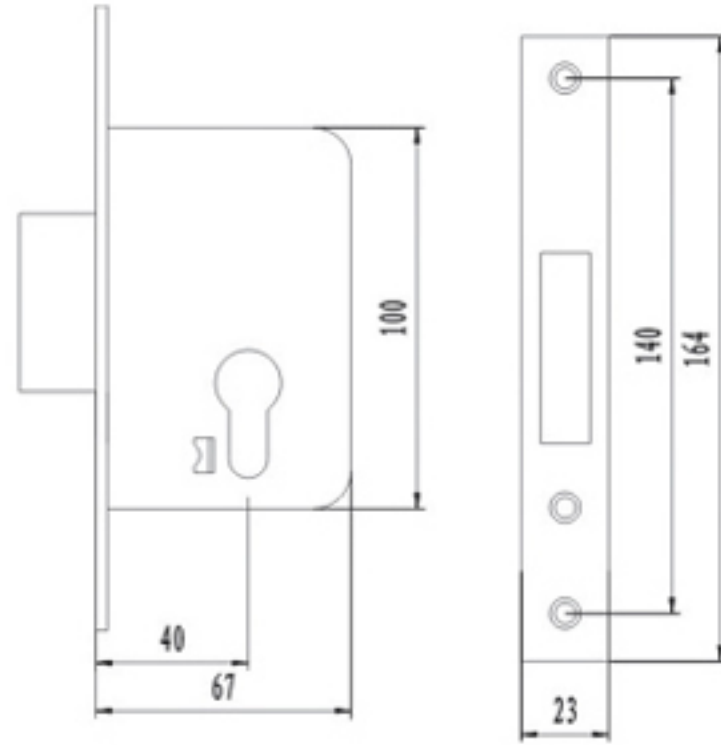

**REF 6040**

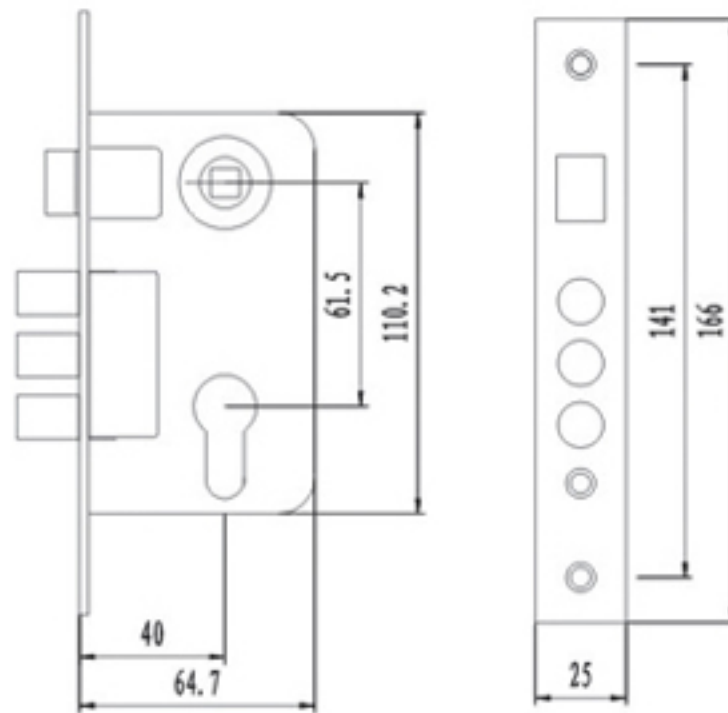

**REF 7011SR-3**

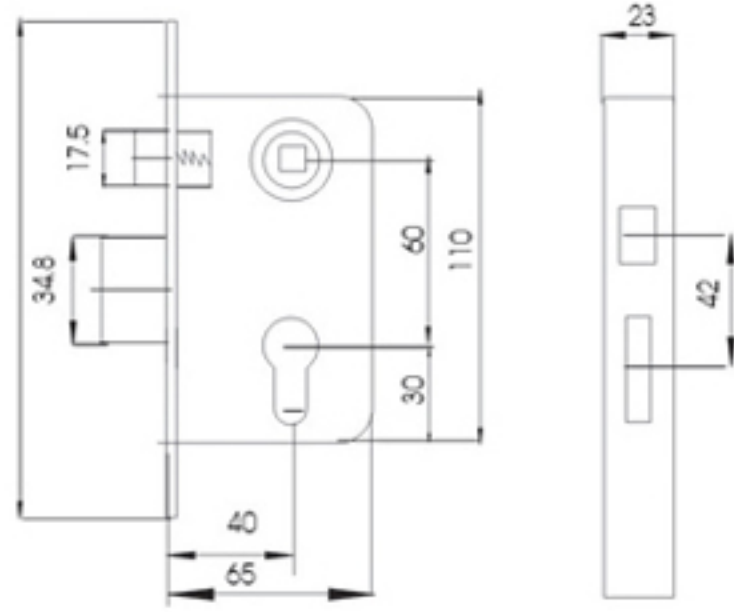

**REF 7011SR**

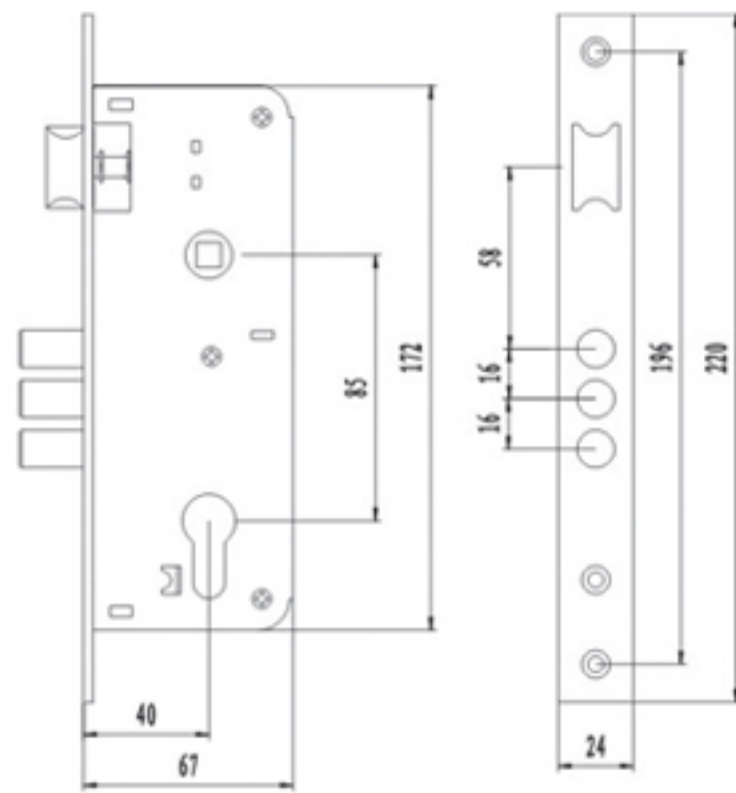

**REF 7011W**

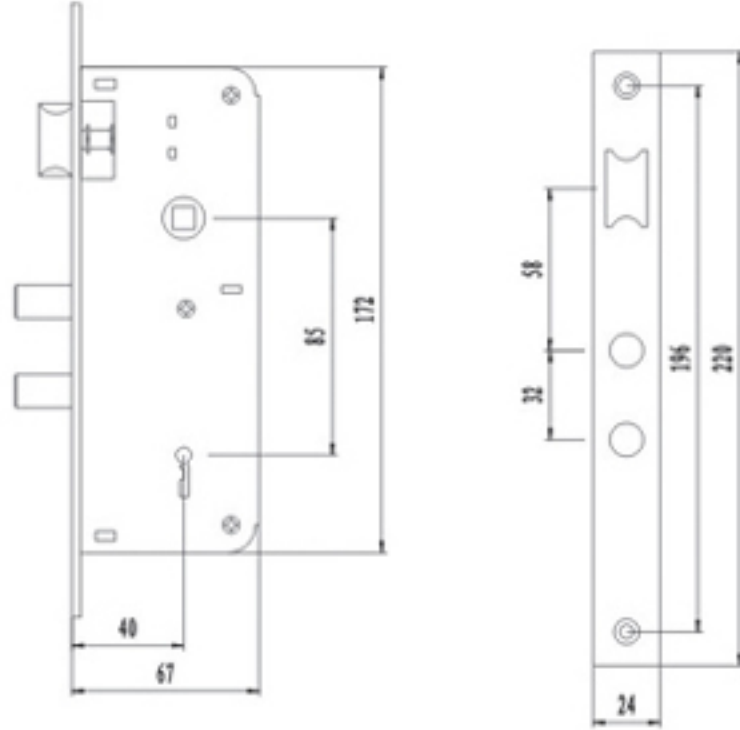

**REF 7011Y**

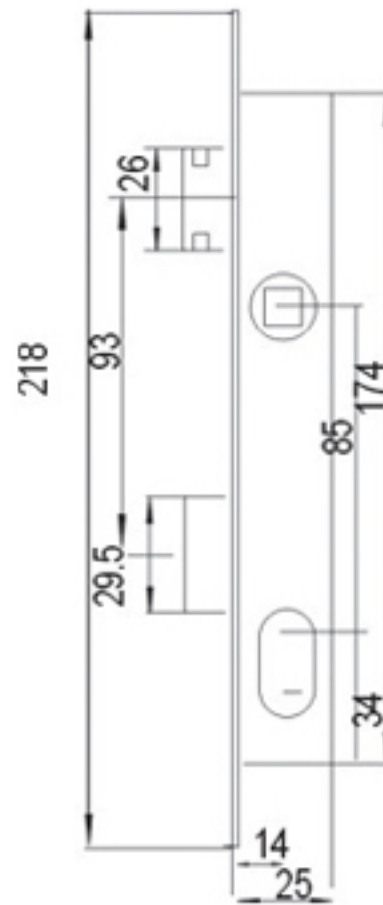

**REF 7704**

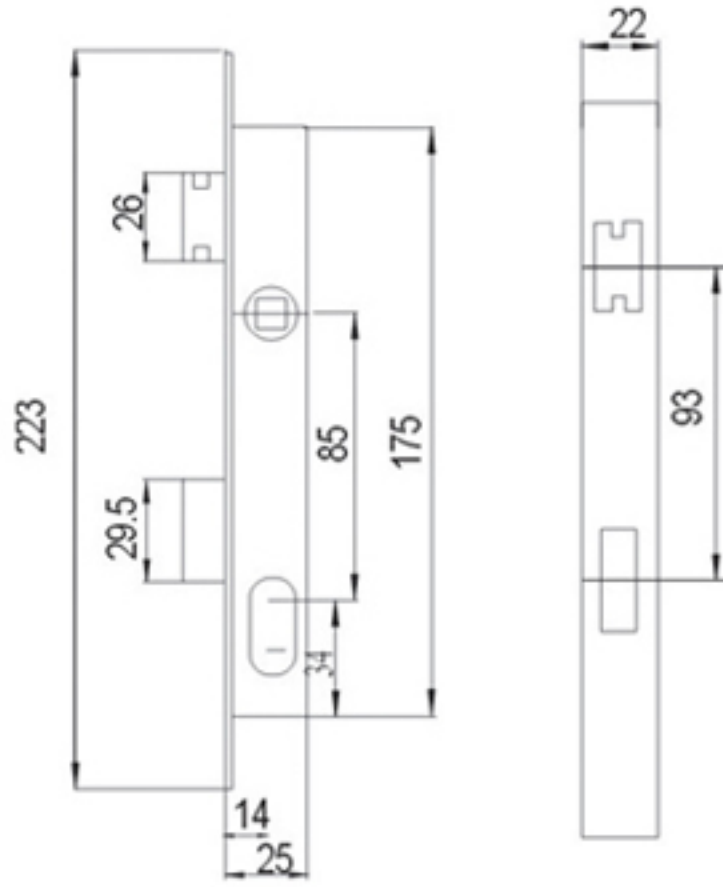

**REF 7704A**

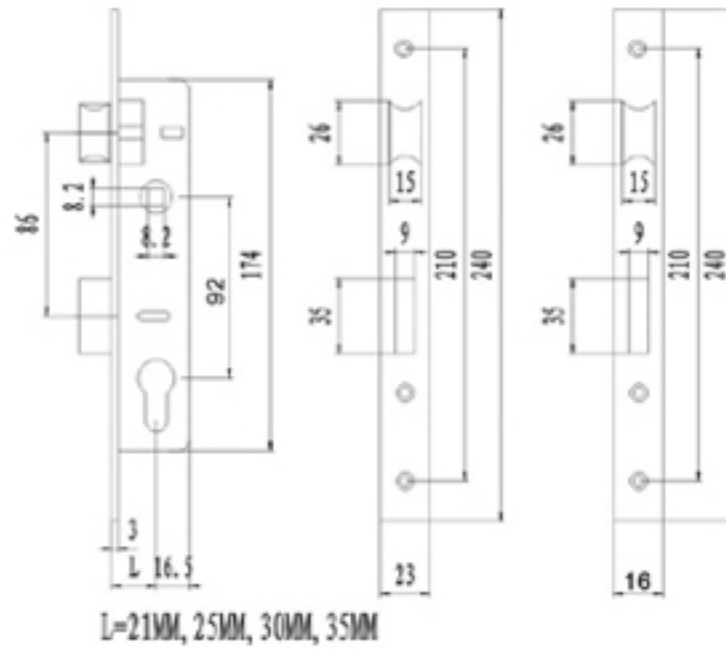

**REF 8805-92**

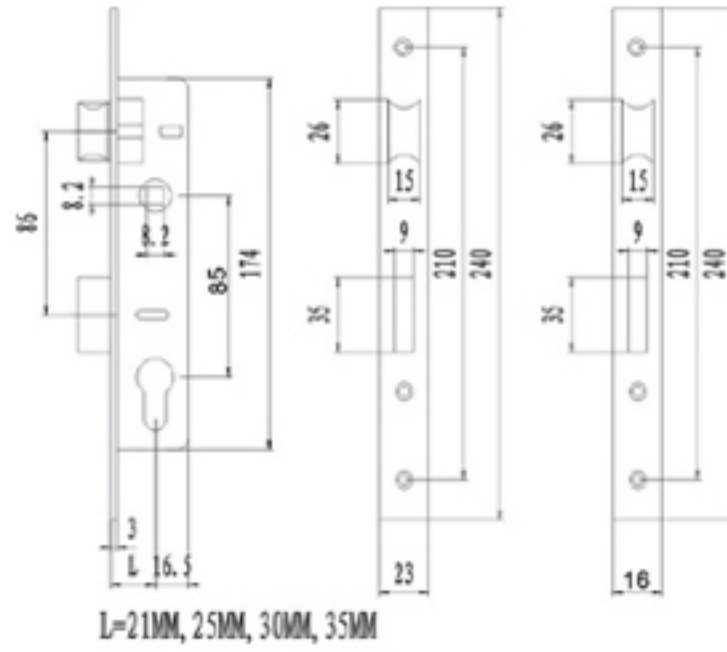

**REF 8805**

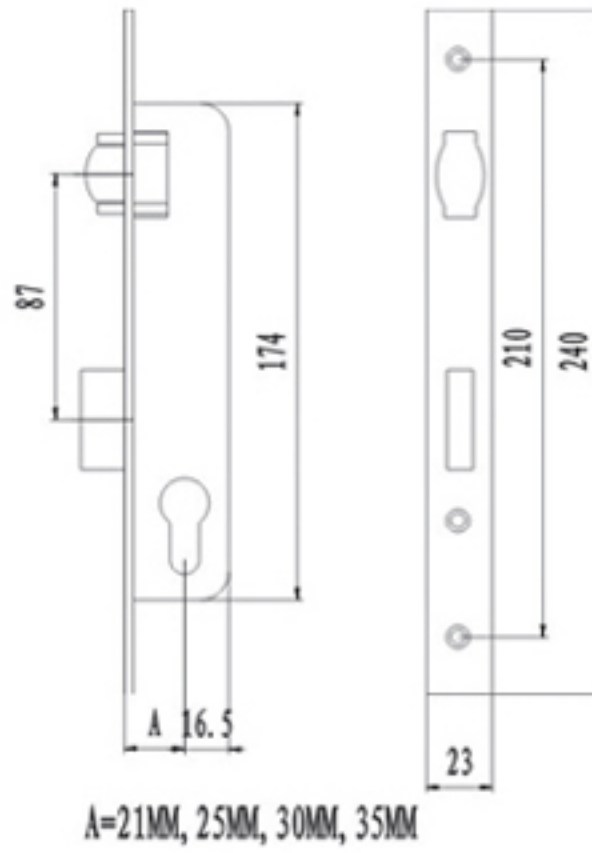

**REF 8806**



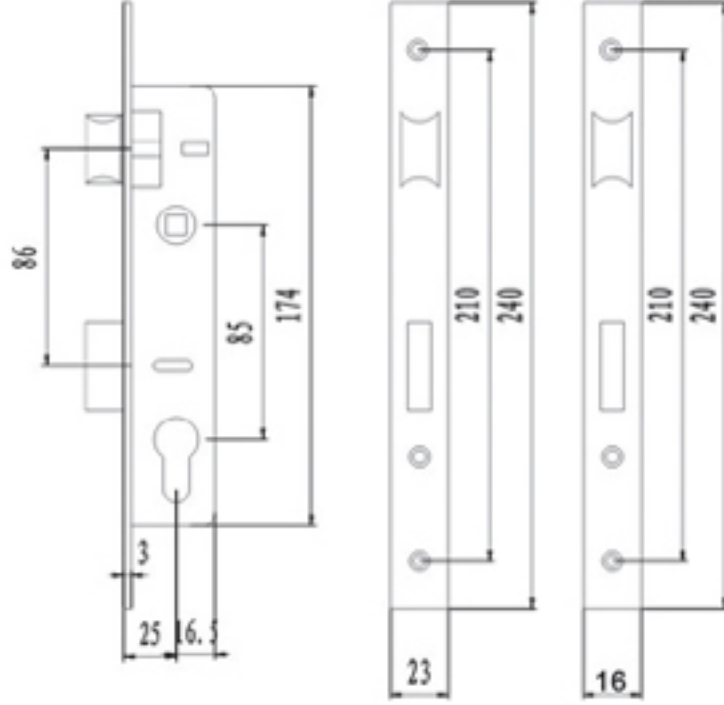

**REF 8825**

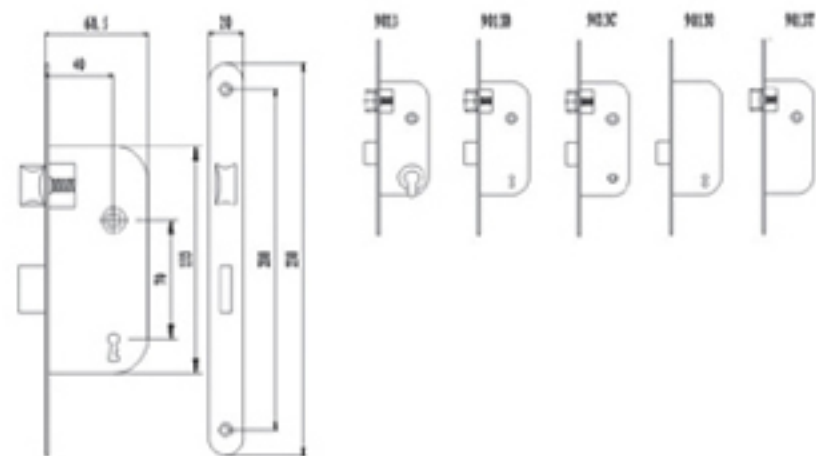

**REF 9013**

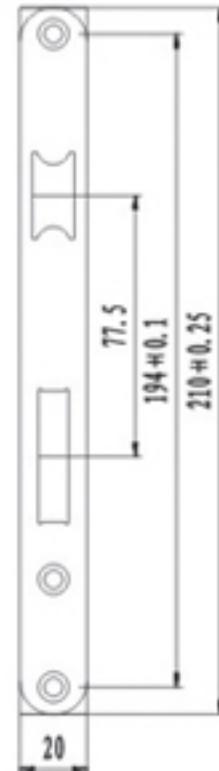
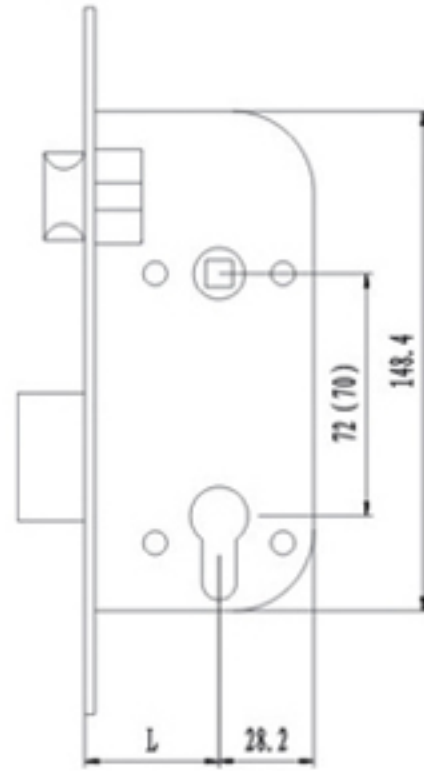

L=40MM, 45MM, 50MM, 55MM, 60MM

**REF 9040**

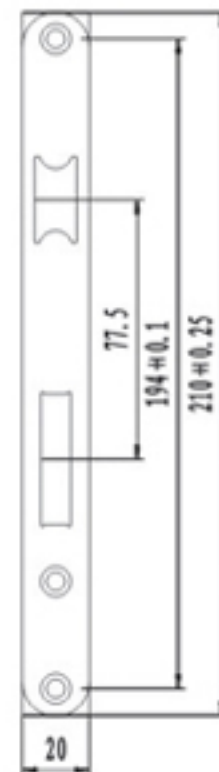
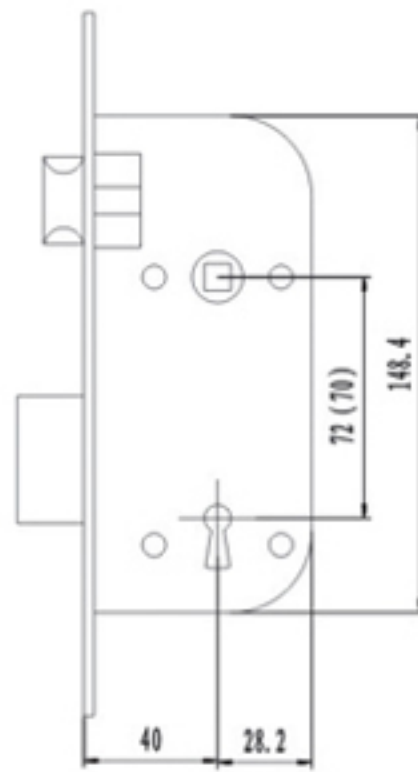

**REF 9040Y**

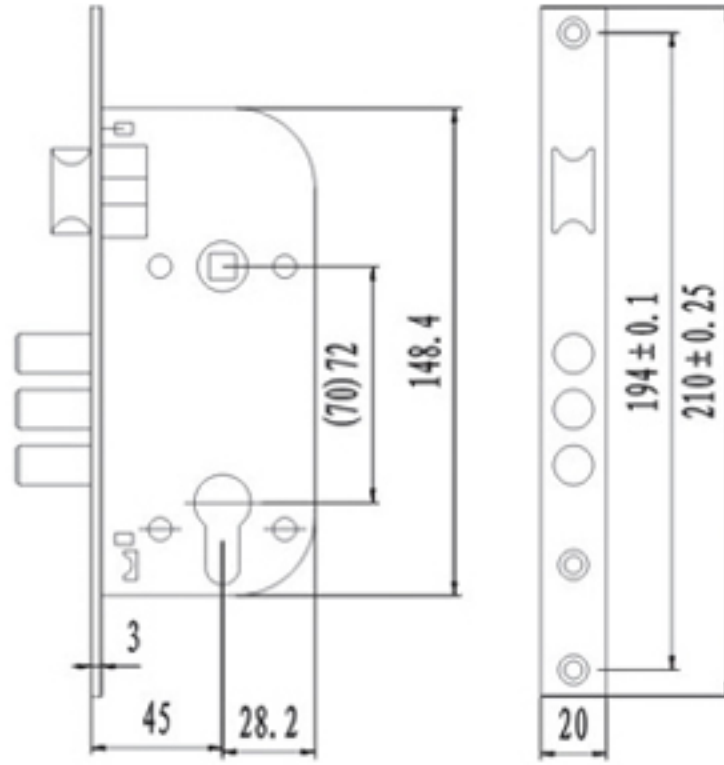

**REF 9045-111**

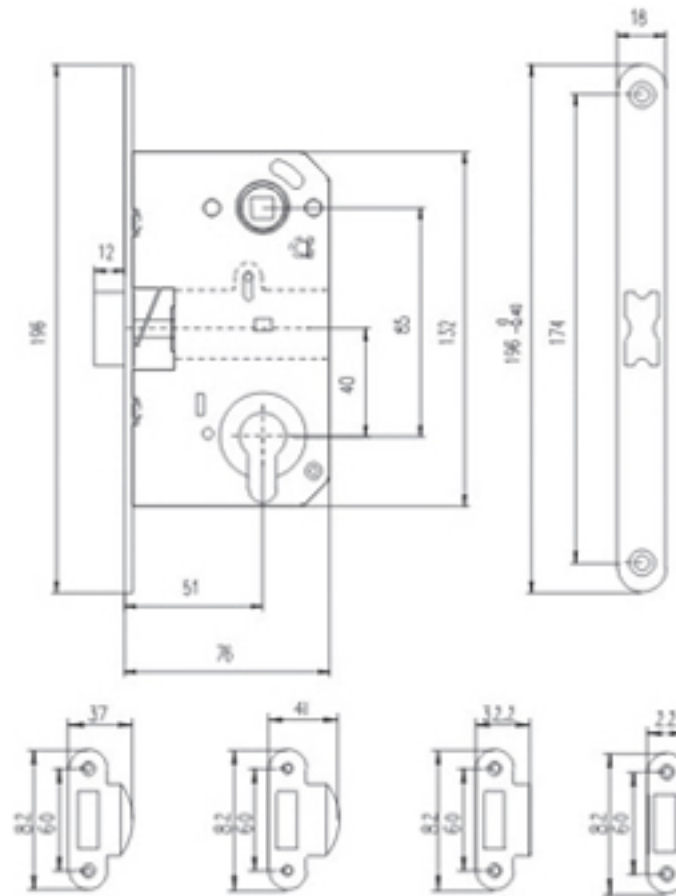

**REF M85C**

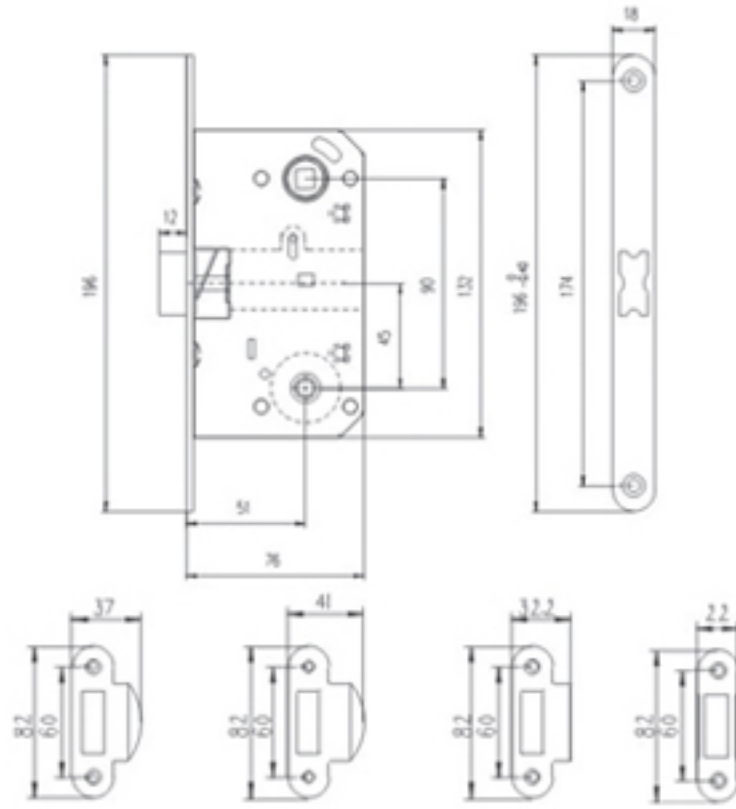

**REF M90B**

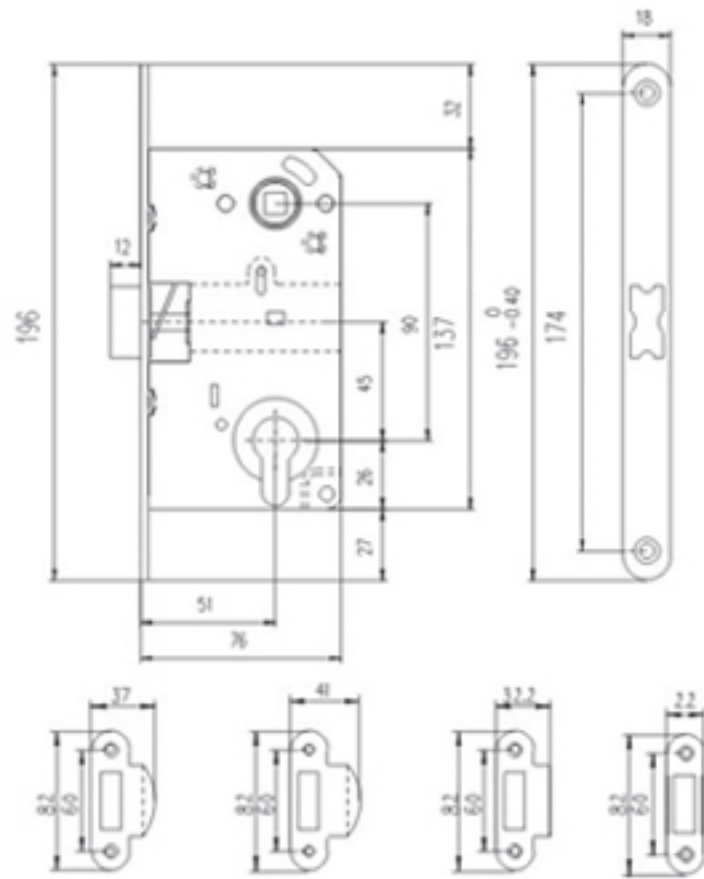

**REF M90C**

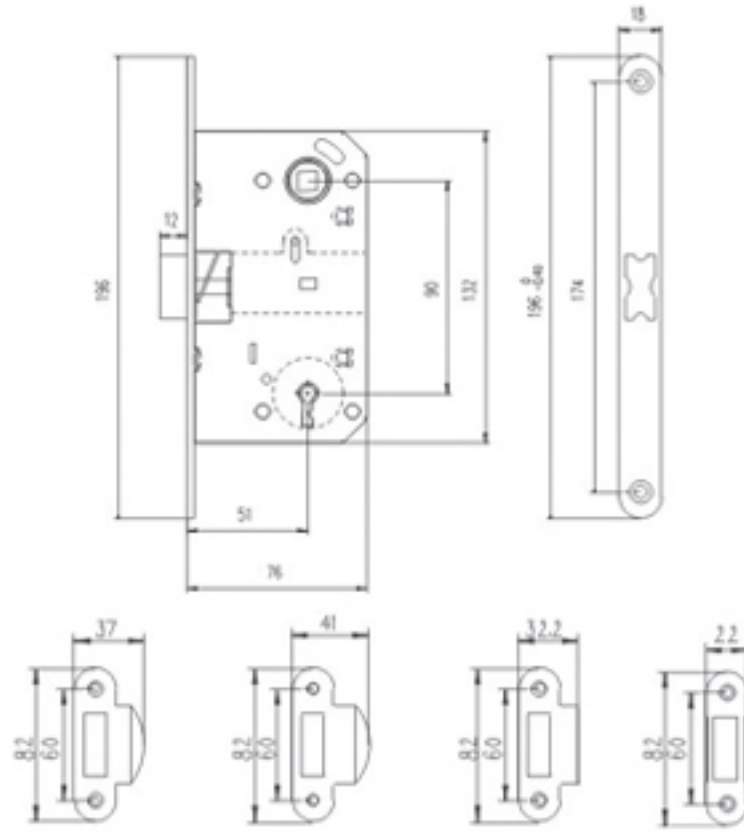

**REF M90K**

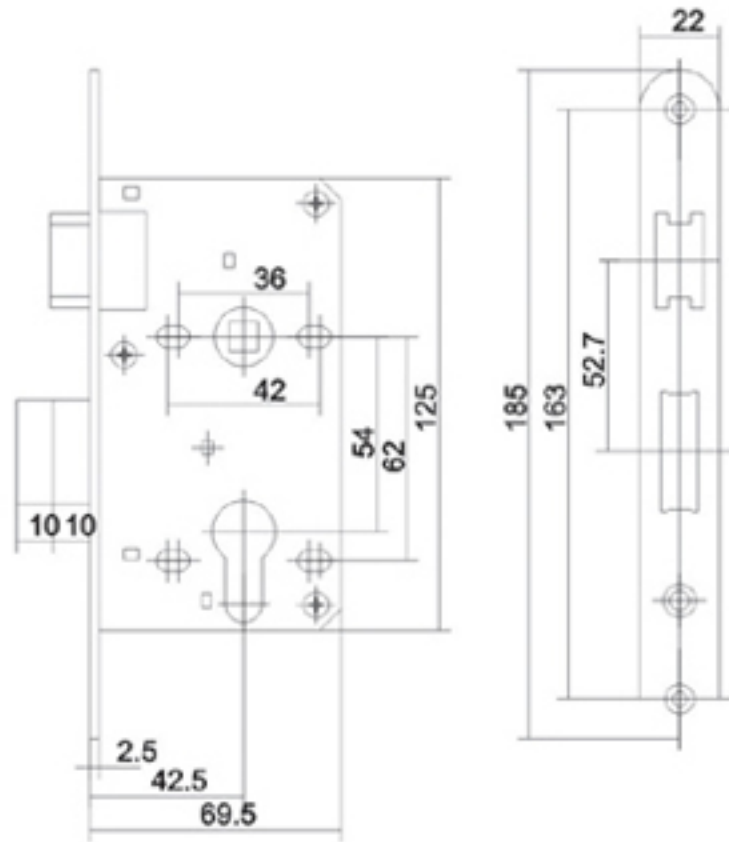

**REF V5040**

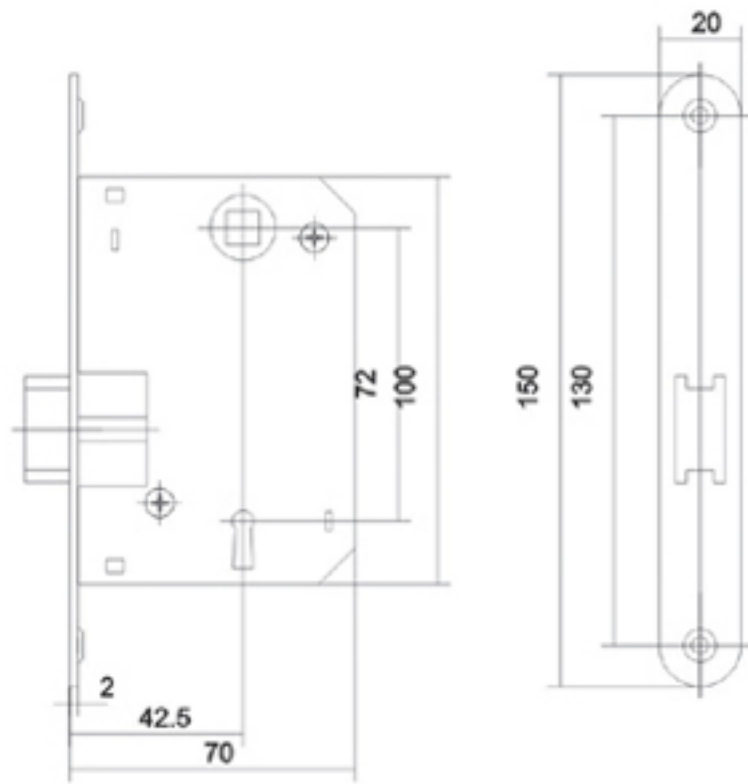

**REF V7240**

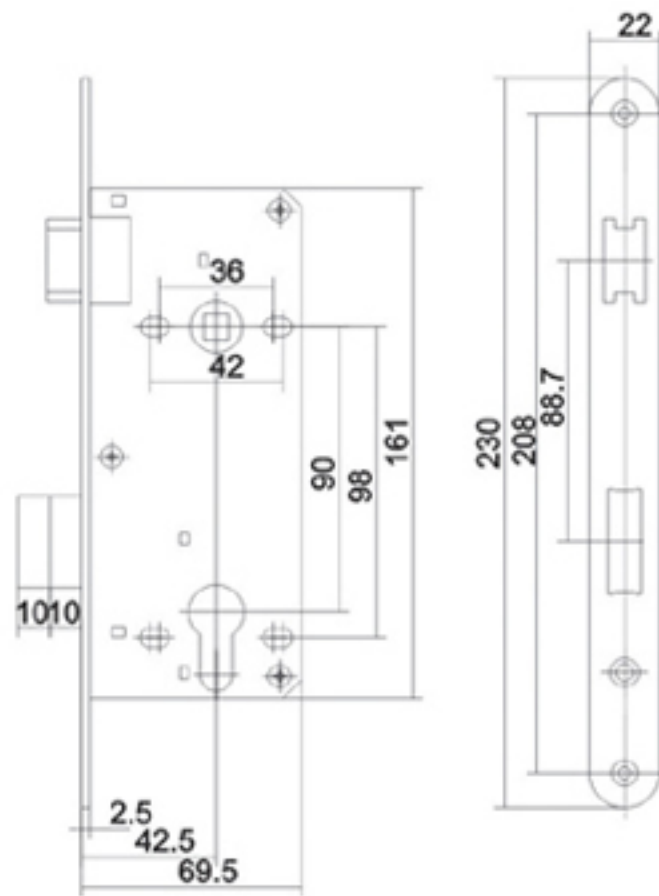

**REF V9040**

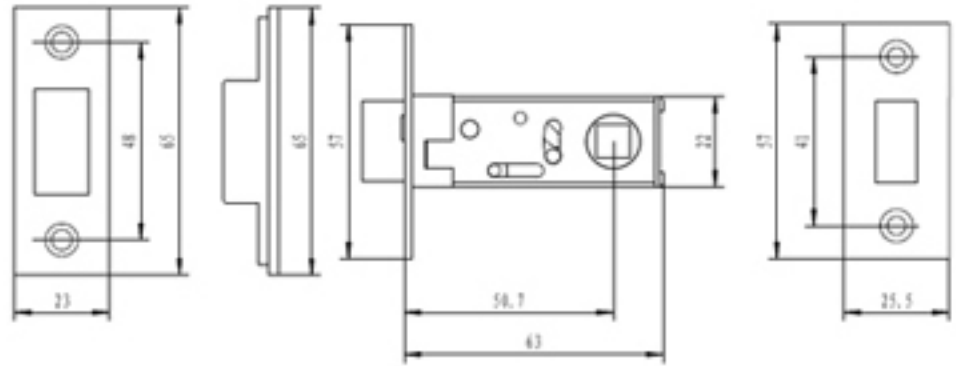
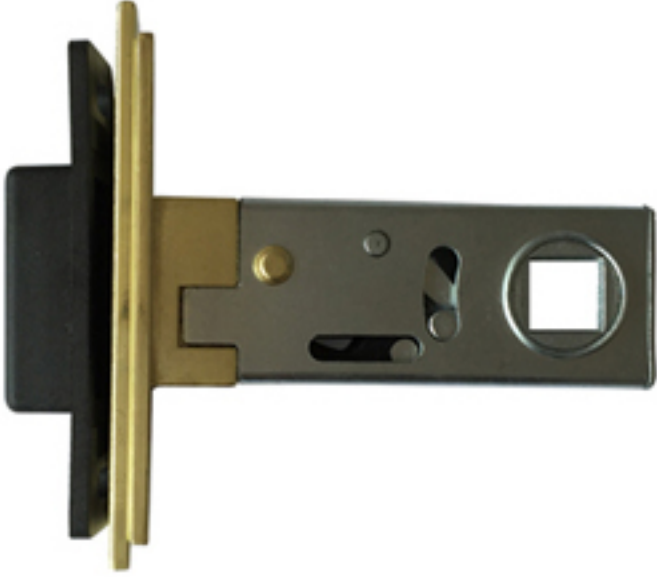

**REF 100M**

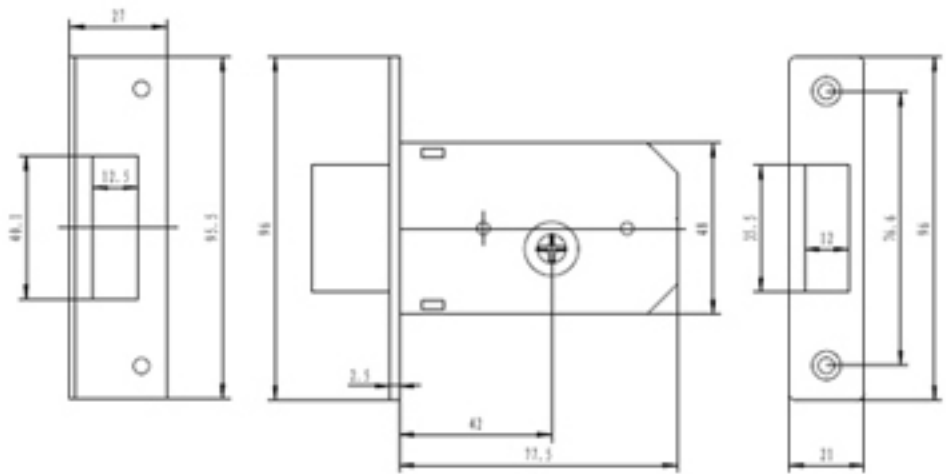

**REF 156F**

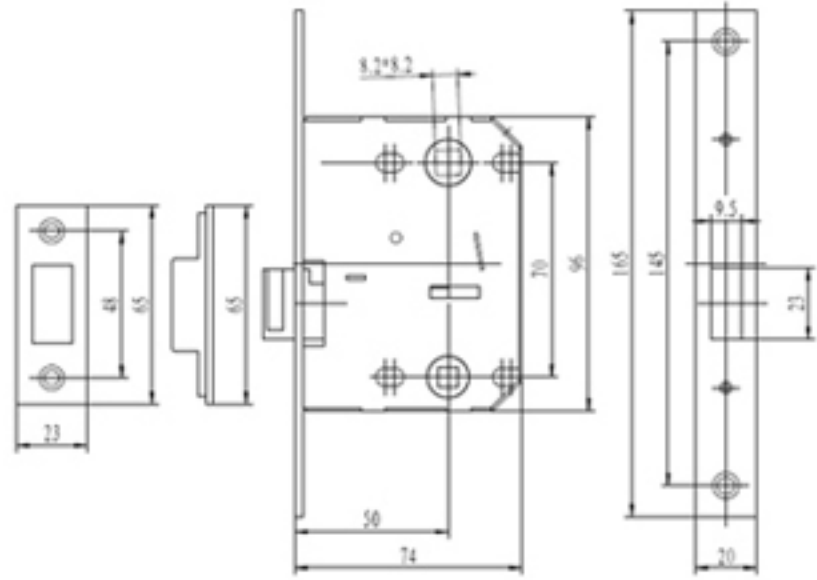

**REF 170M**

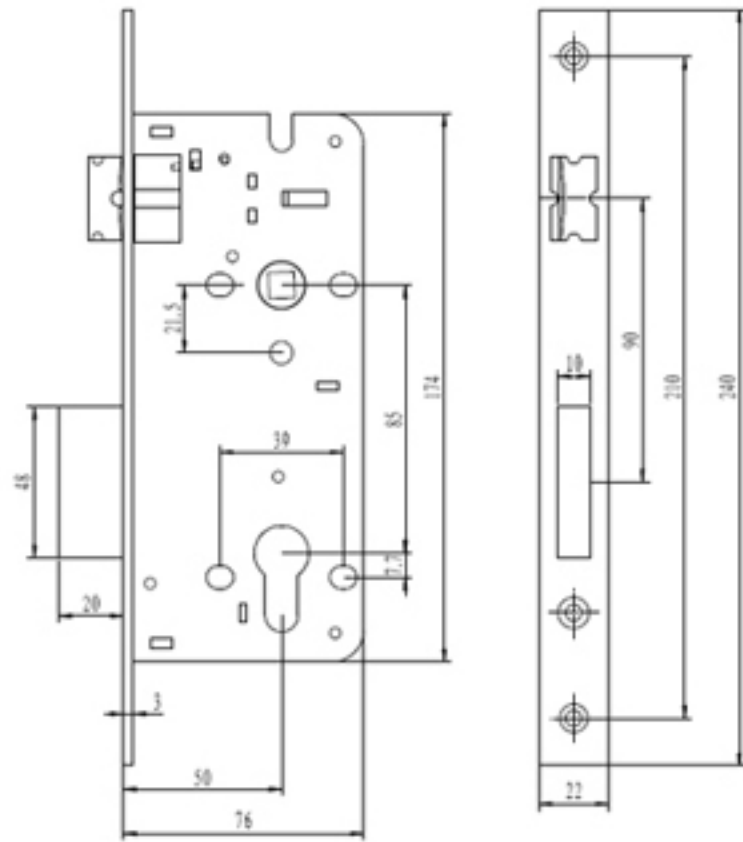

**REF 185-1**



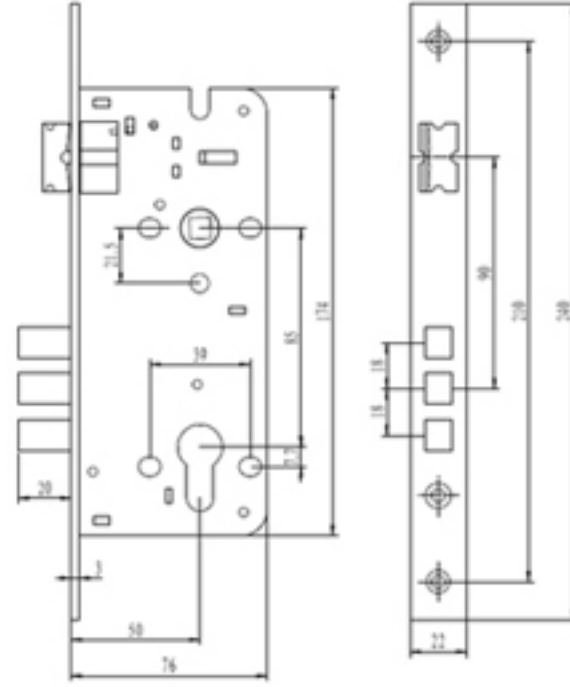

**REF 185-3F**

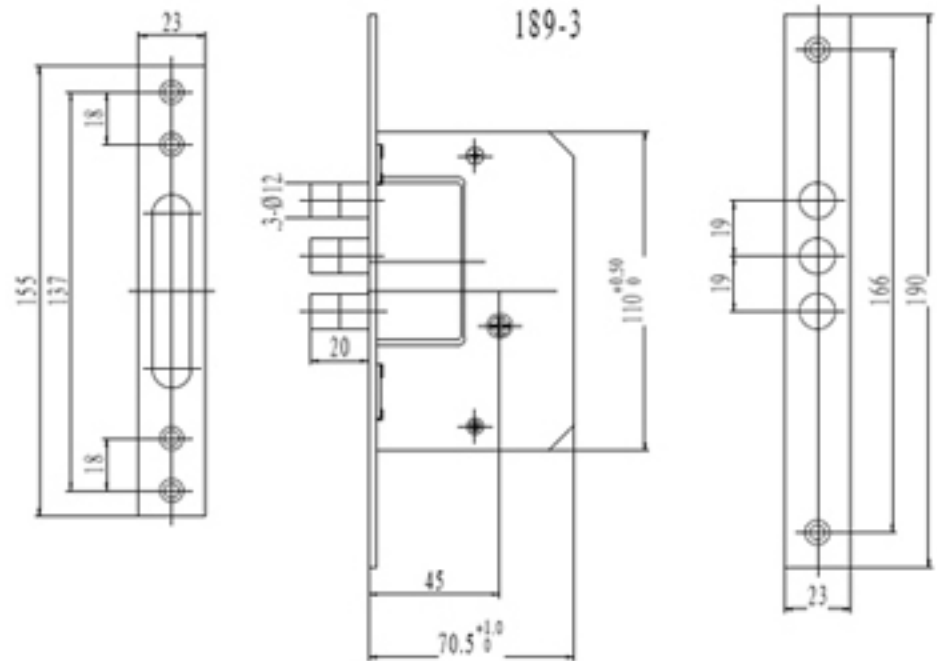

**REF 189-3**

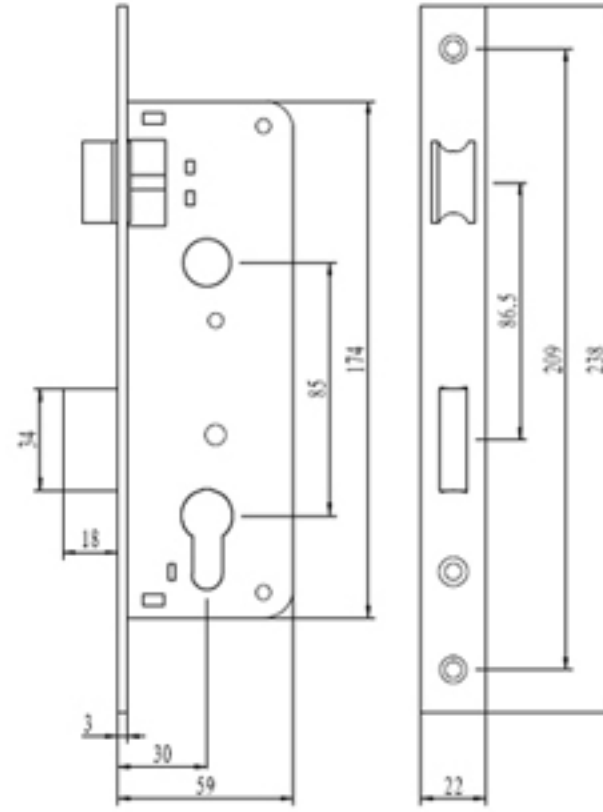

**REF 262**

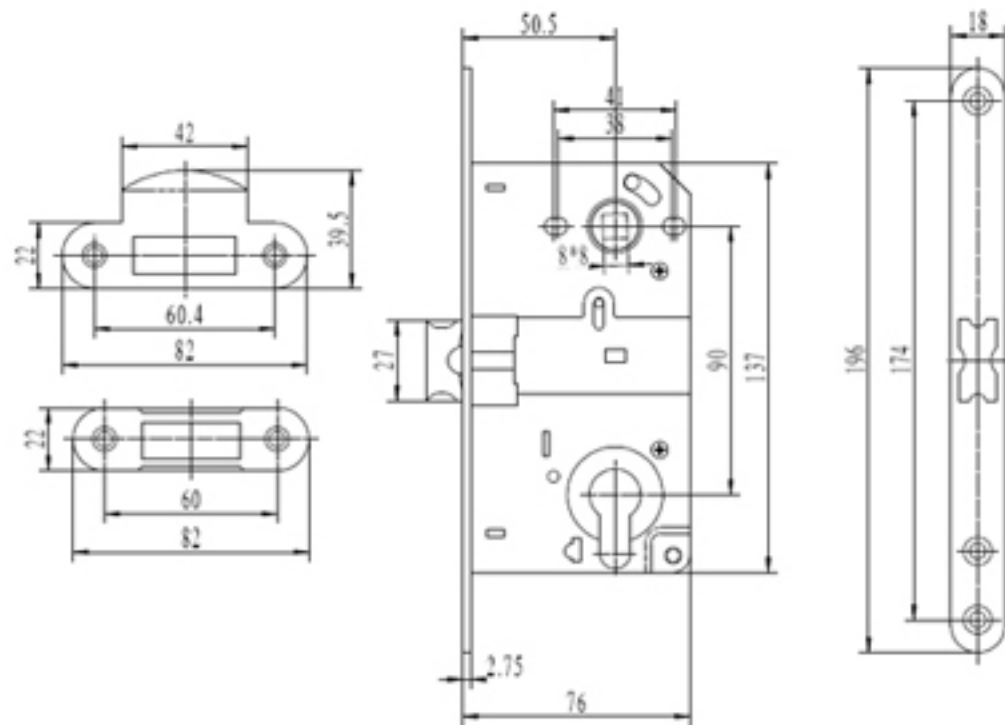

**REF 385**

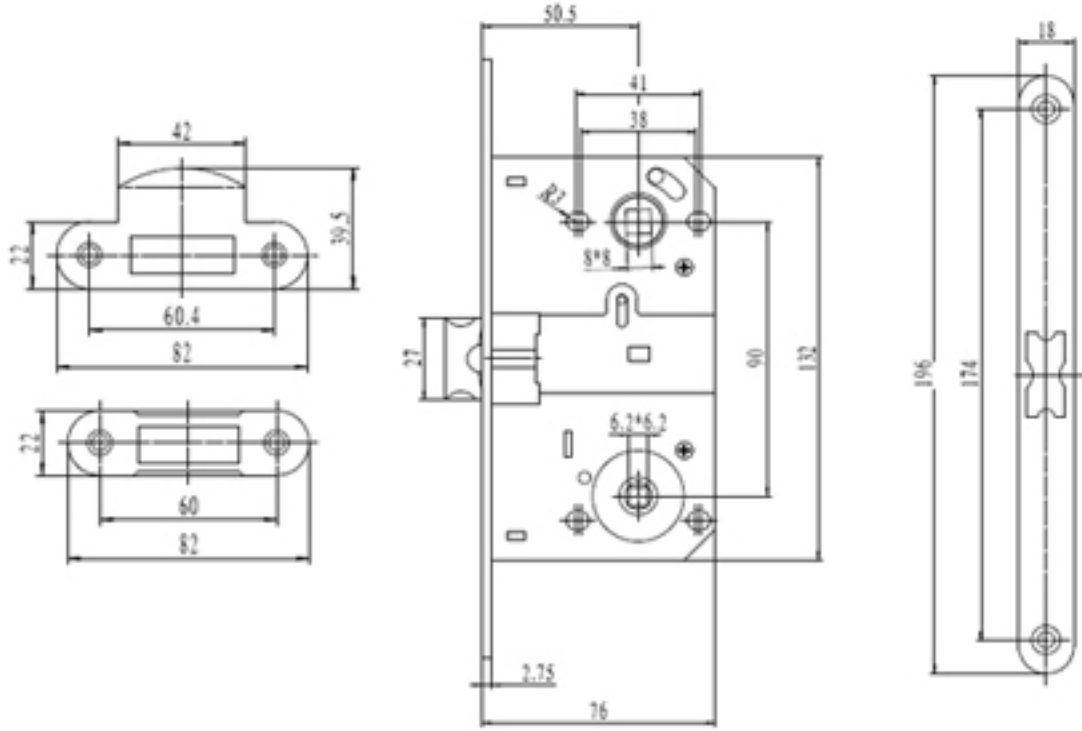

**REF 390**

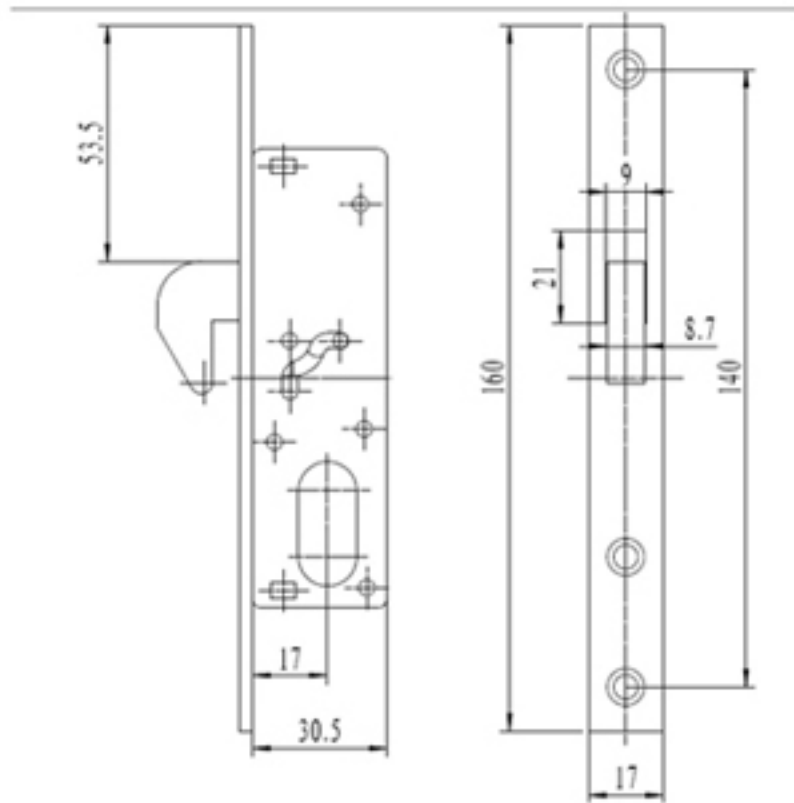

**REF 410SH**

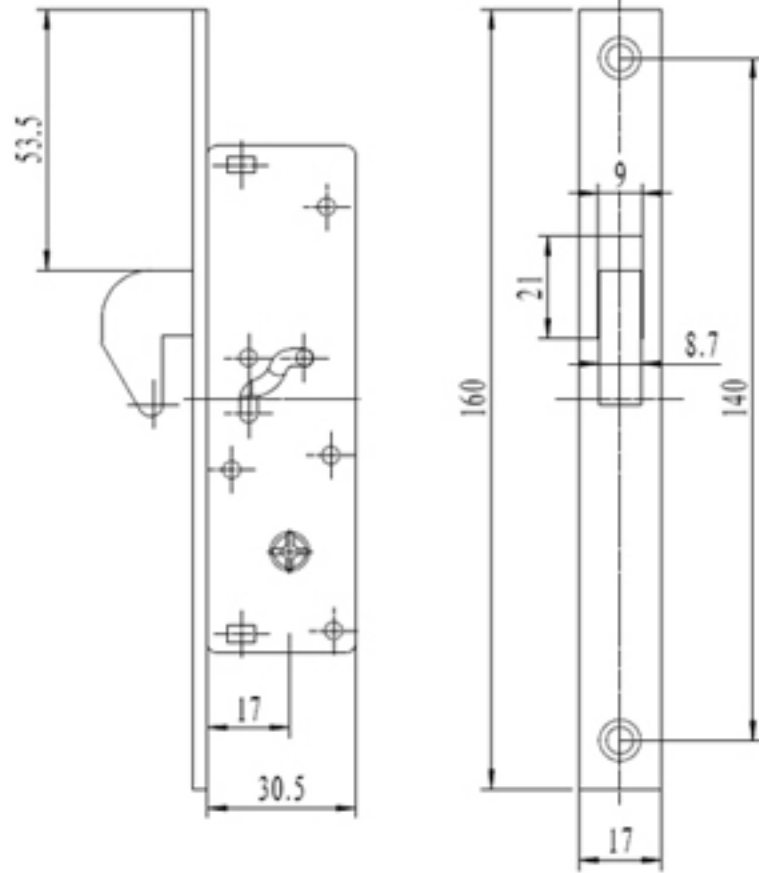

**REF 410SHO**

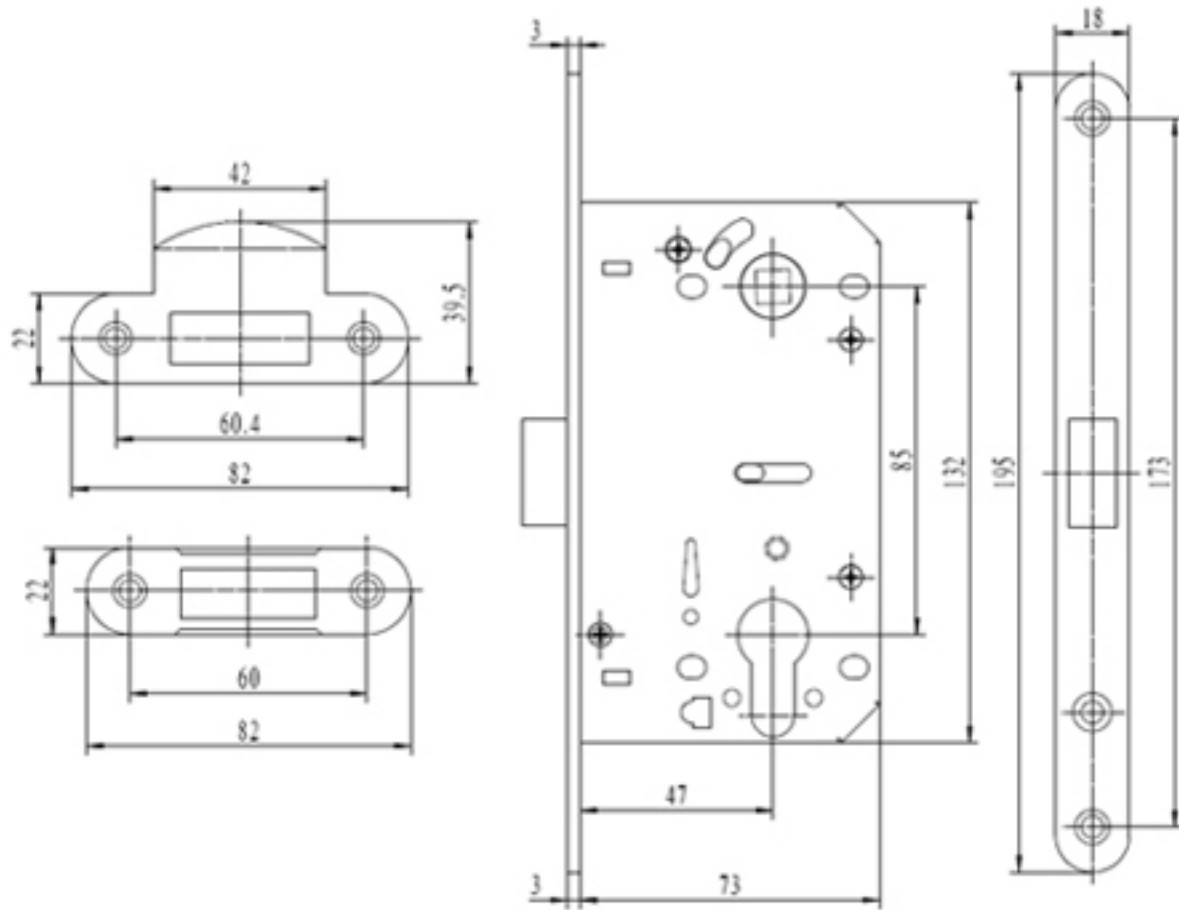

**REF 600**

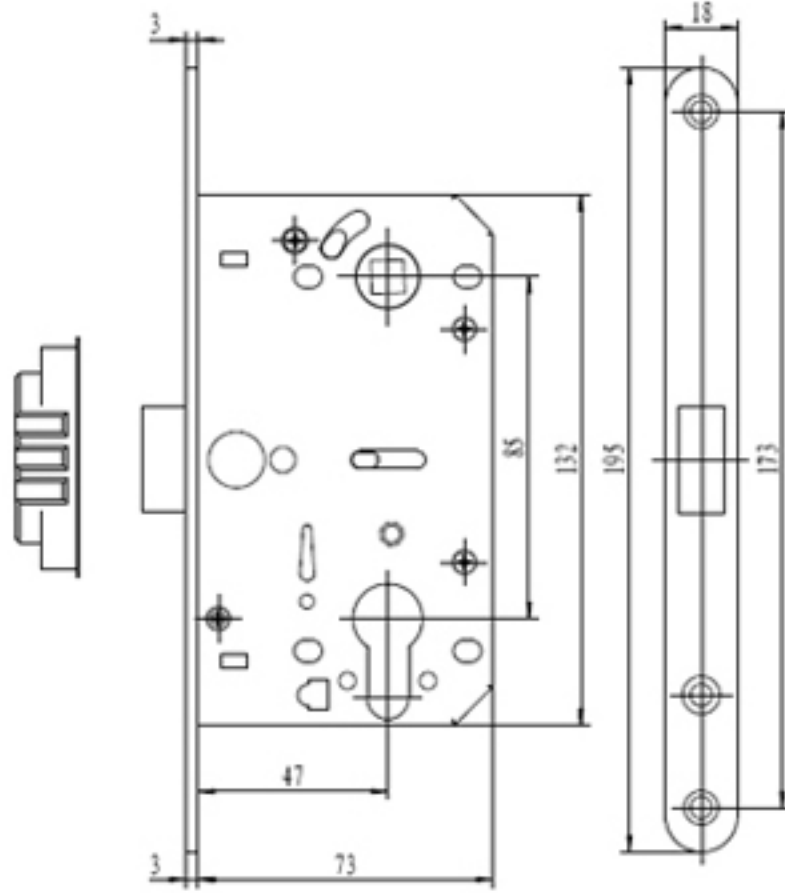

**REF 600M**

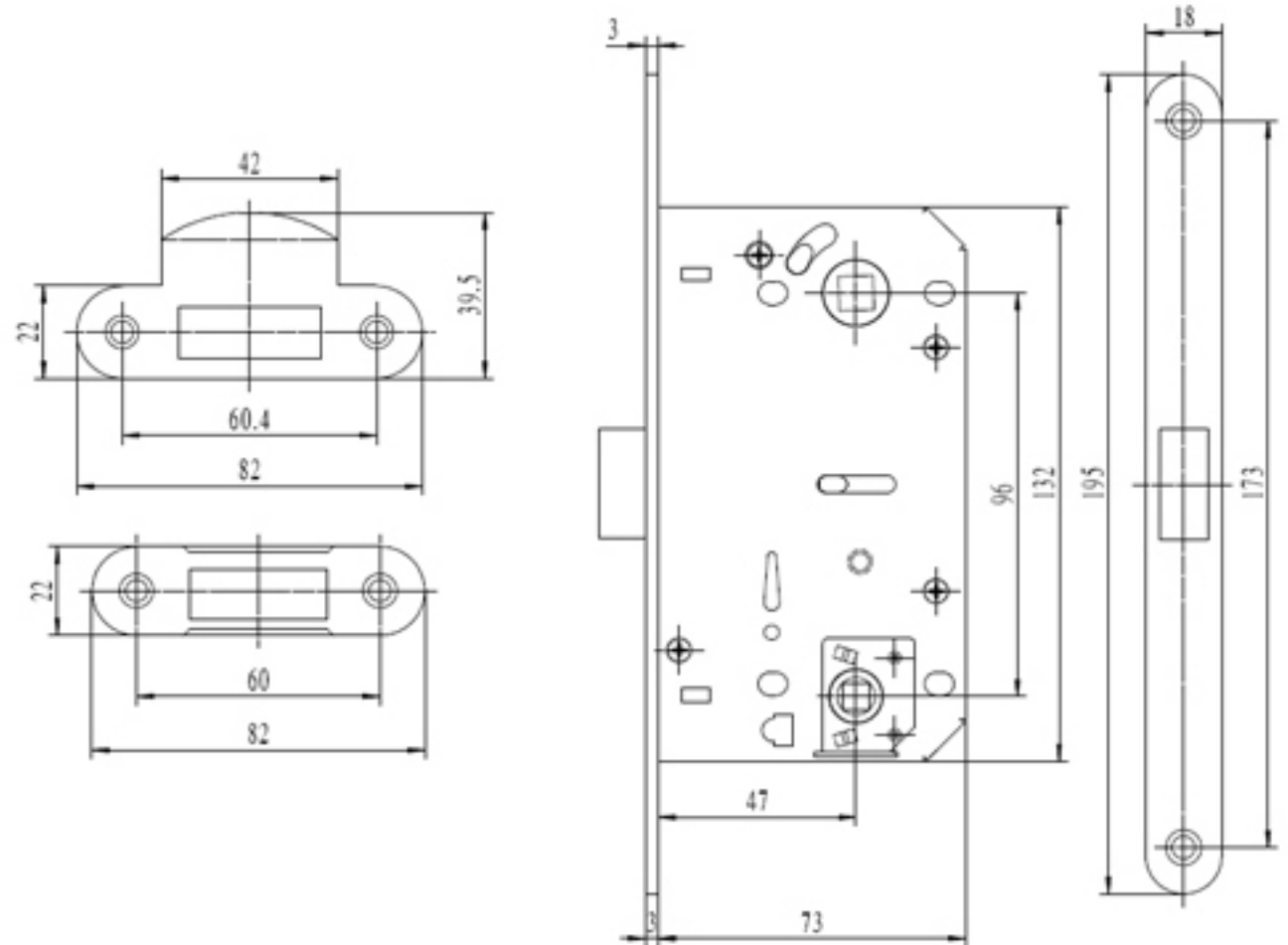

**REF 600W**

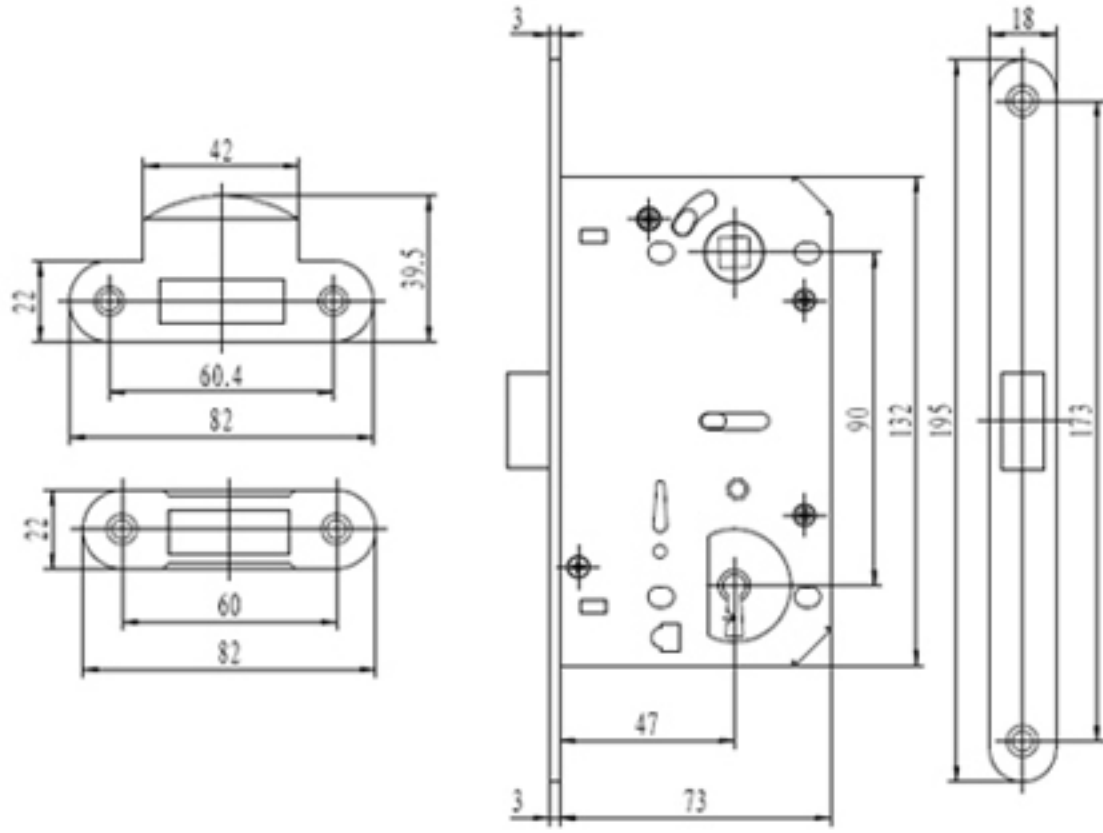

**REF 600Y**

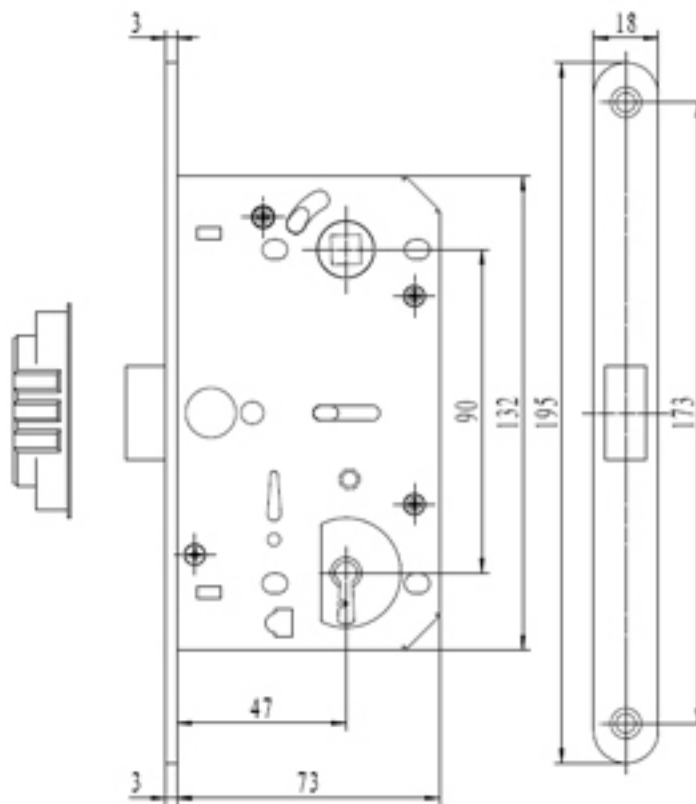

**REF 600Y-M**

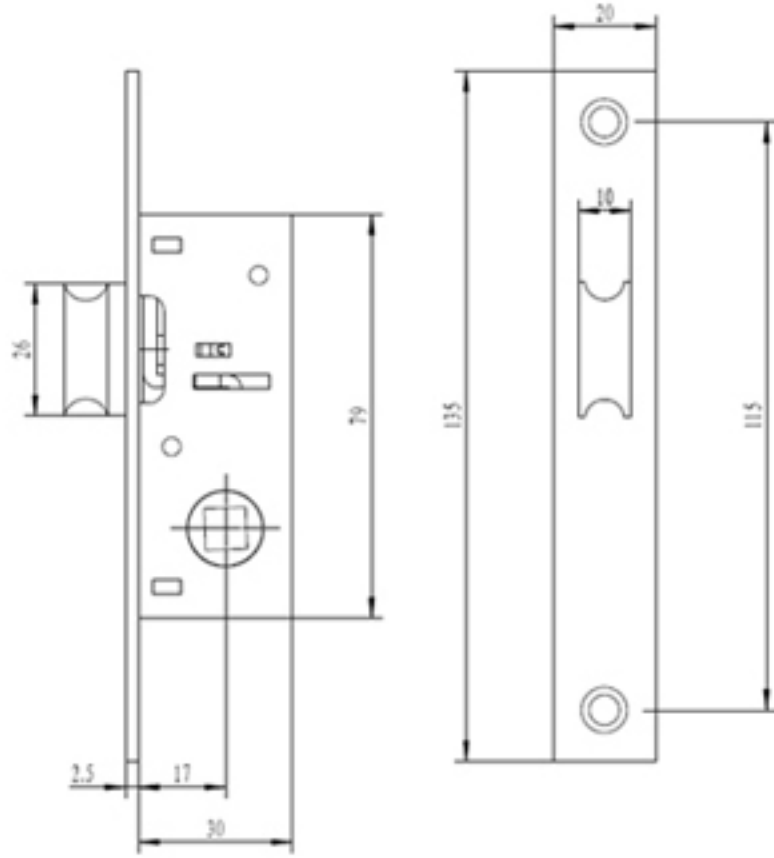

**REF 650-1**

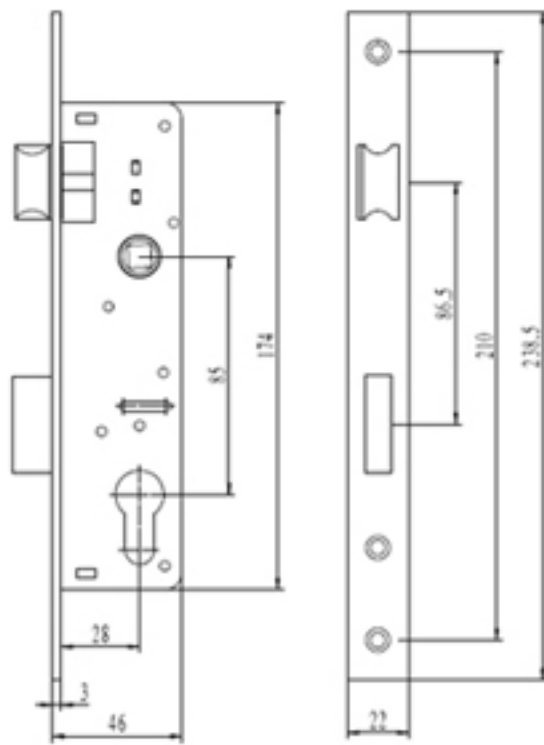

**REF 730**

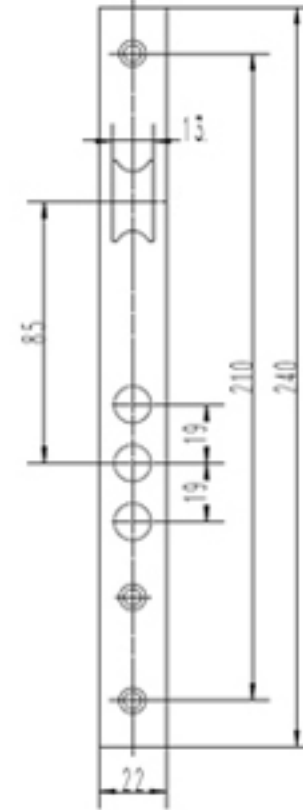
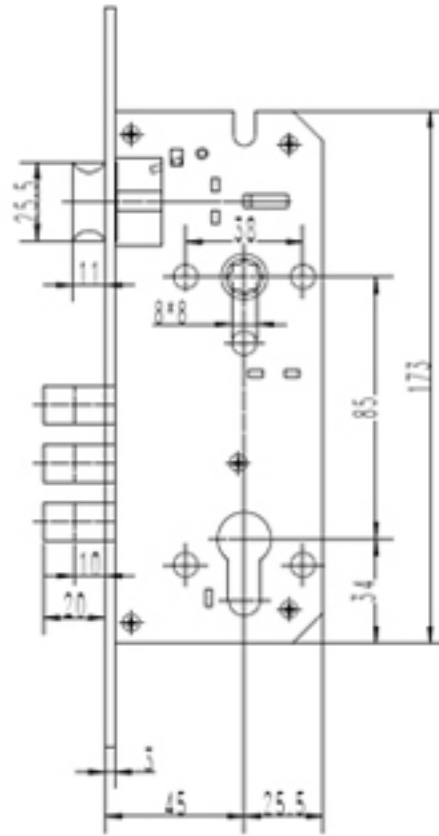

**REF 745-3Y**

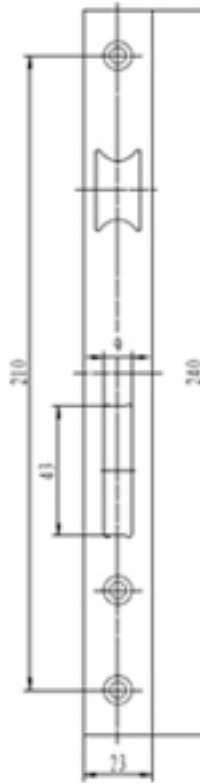
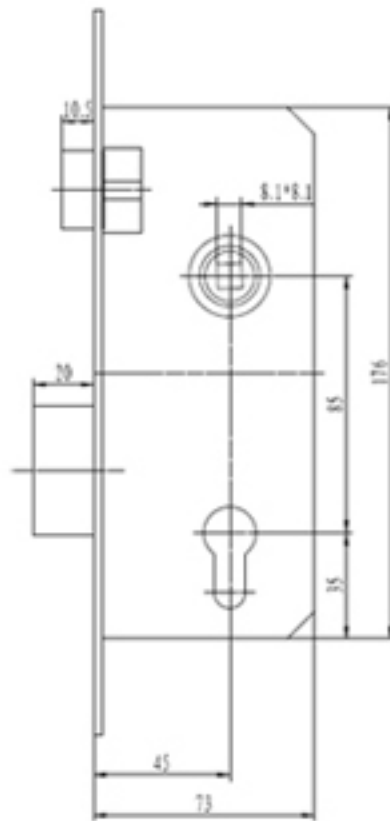

**REF 945**



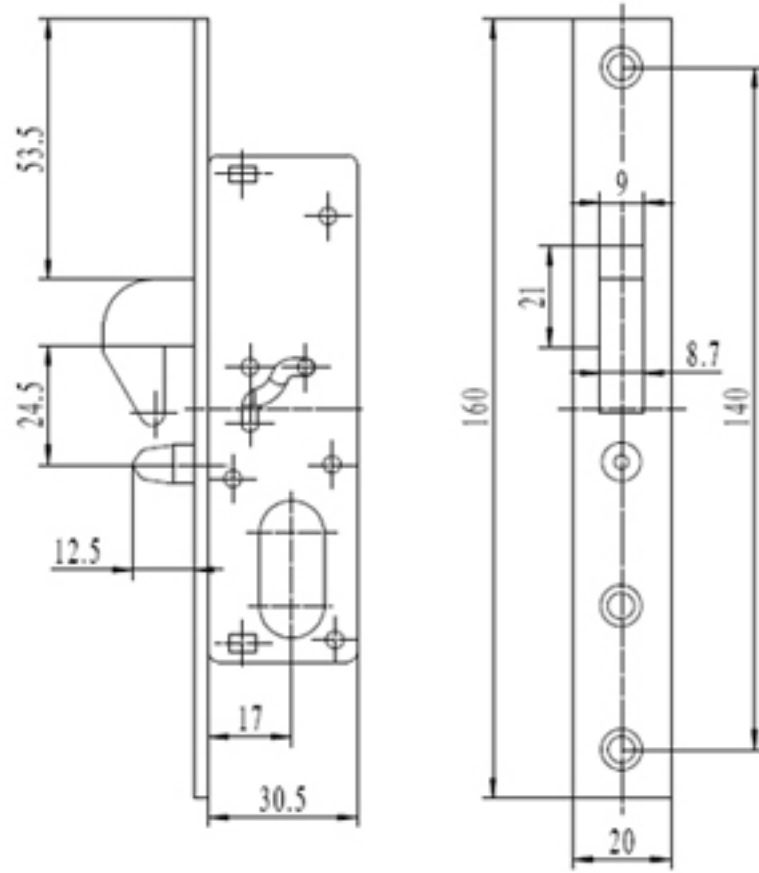

**REF 1680HP**

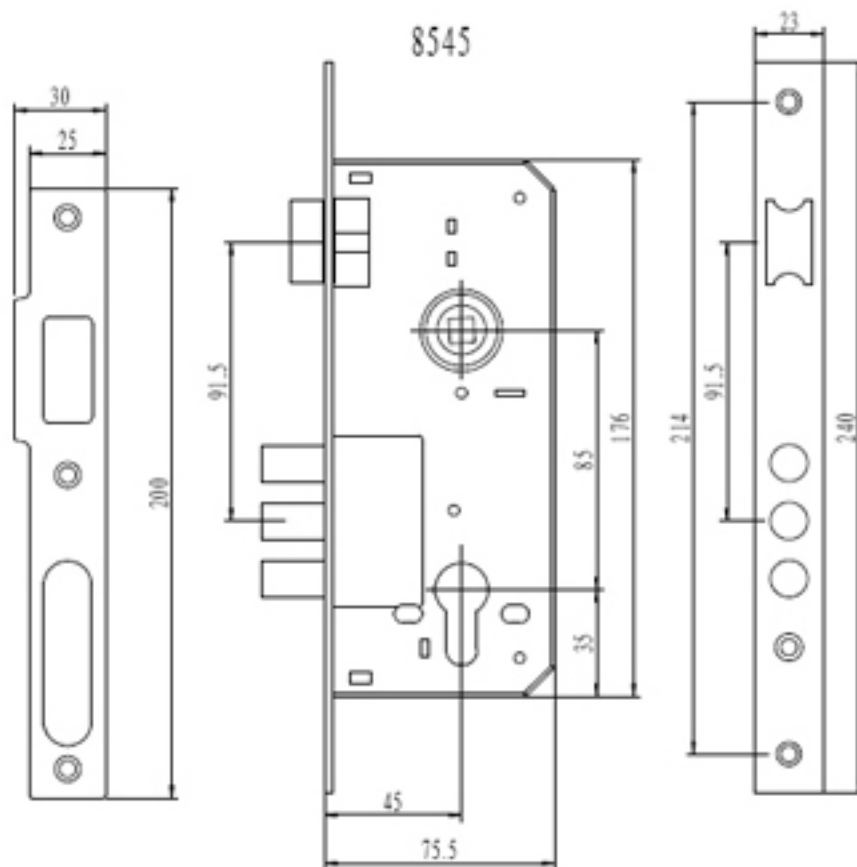

**REF 8545-3R**

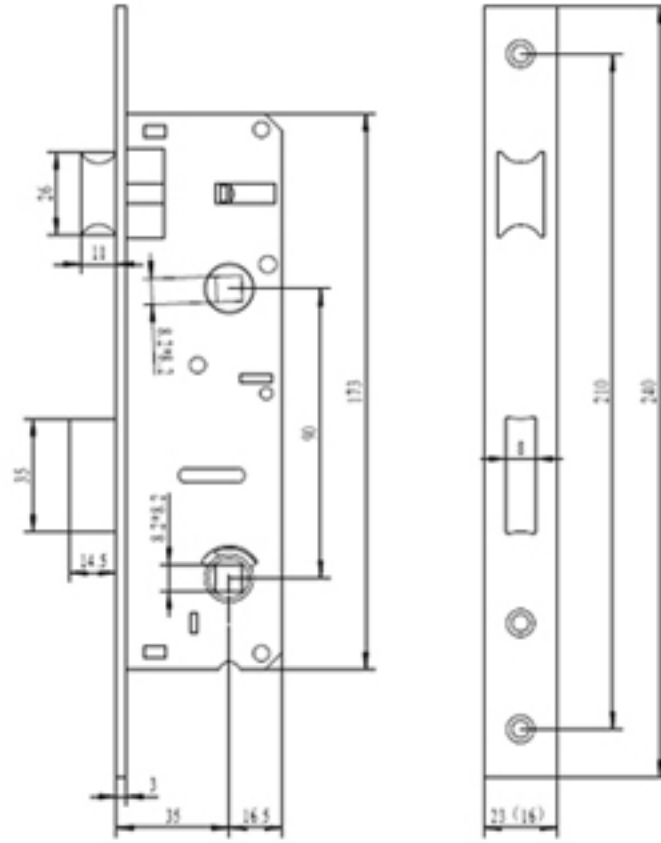

**REF 8835W**

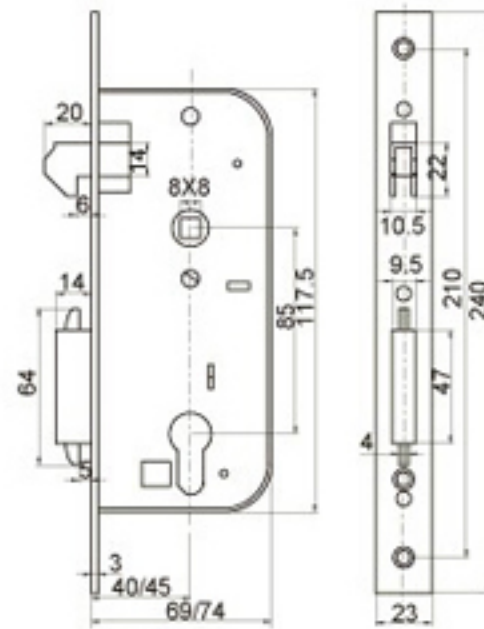

**REF 52240**

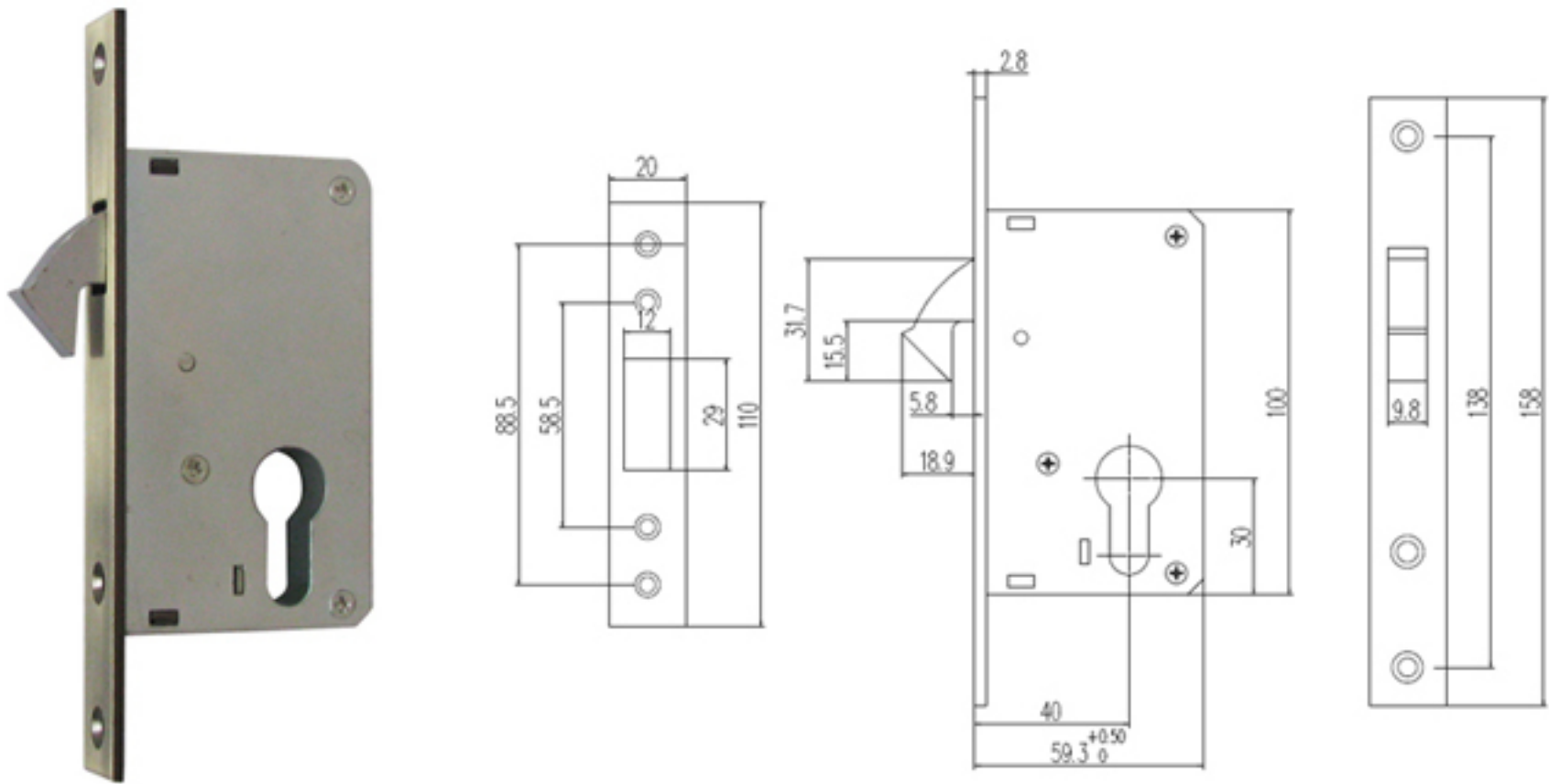

**REF G40**

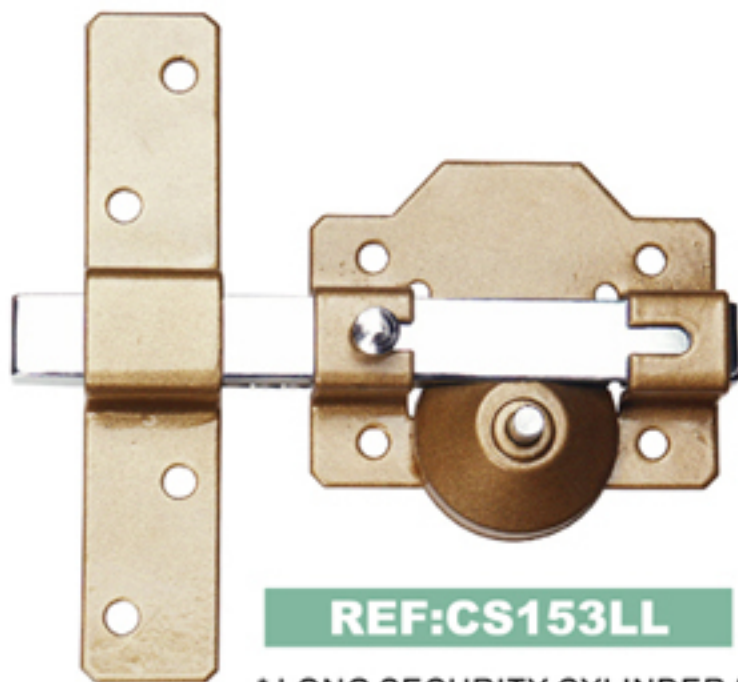

**REF:CS153LL**

- \* LONG SECURITY CYLINDER 50MM WITH 6 PINS
- \* STEEL BOLT CHROME PLATED 153MM
- \* BOLT OPERATED BY KEY FROM OUTSIDE AND BUTTON FROM INSIDE

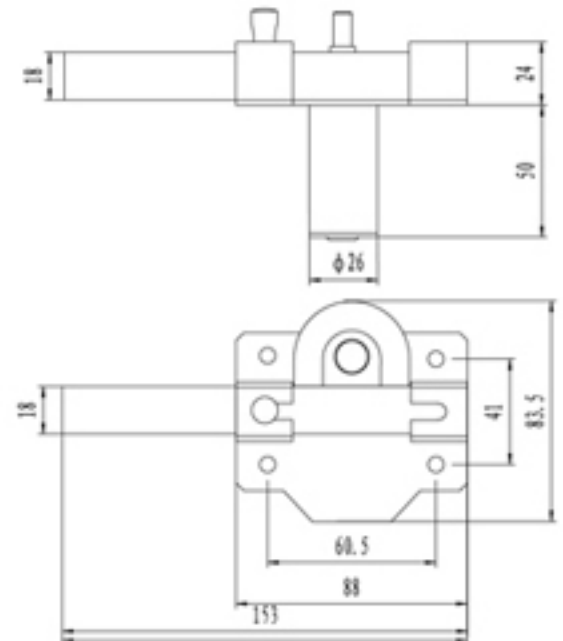

**REF CS153LL**

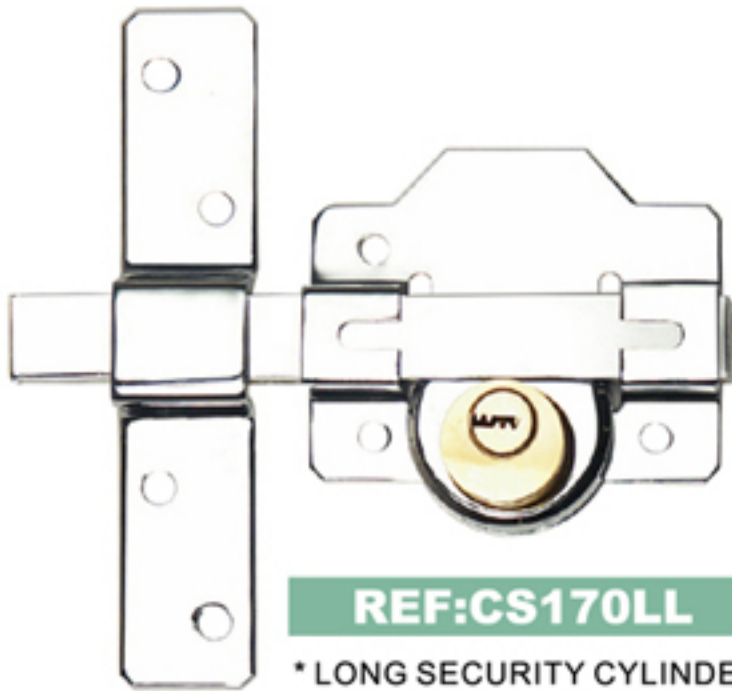

**REF:CS170LL**

- \* LONG SECURITY CYLINDER 50MM WITH 6 PINS
- \* STEEL BOLT CHROME PLATED 170MM
- \* BOLT OPERATED BY KEY FROM BOTH SIDES
- \* FINISH: PAINTED, CHROME PLATED, BRASS PLATED

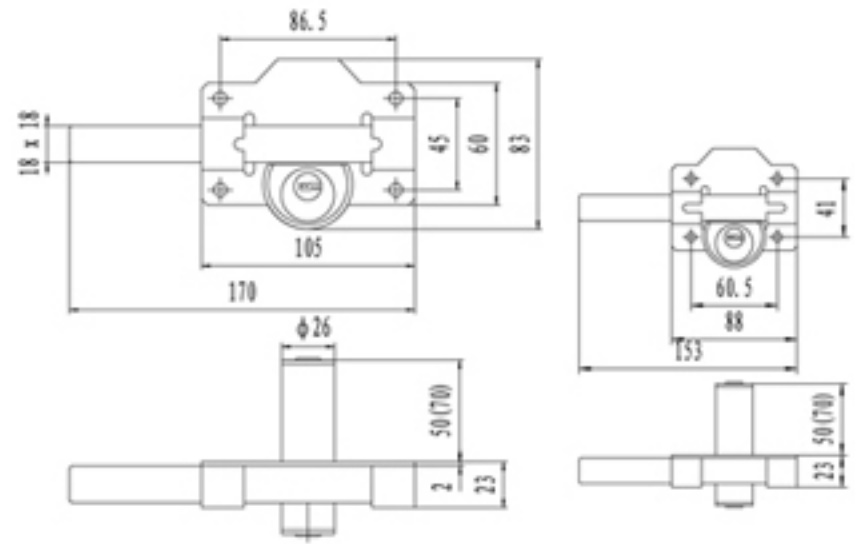

**REF CS170LL**

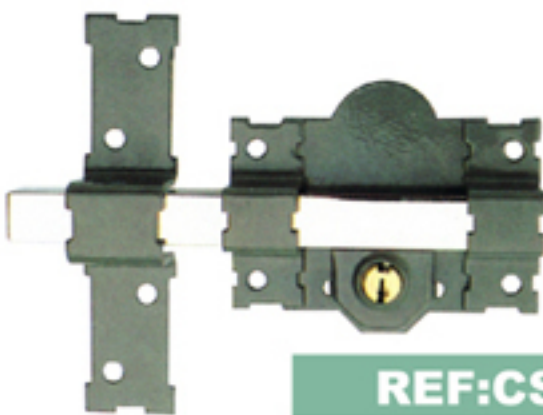

**REF:CS182LL**

- \* LONG SECURITY CYLINDER 50MM WITH 6 PINS
- \* STEEL BOLT CHROME PLATED 182MM
- \* BOLT OPERATED BY KEY FROM BOTH SIDES
- \* FINISH: PAINTED, CHROME PLATED, BRASS PLATED

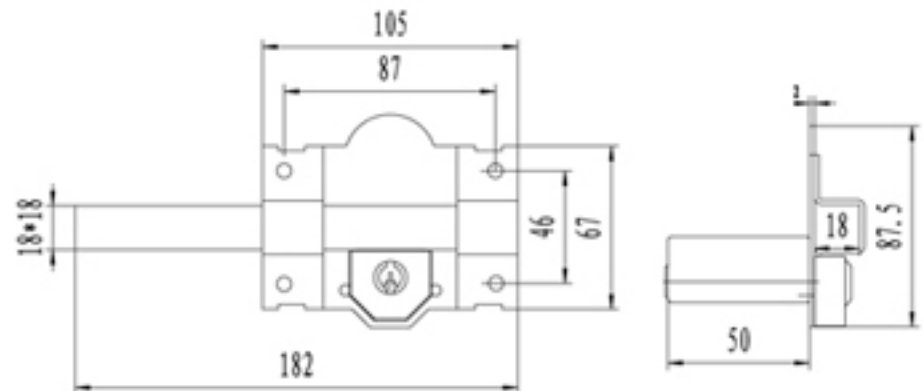

**REF CS182LL**

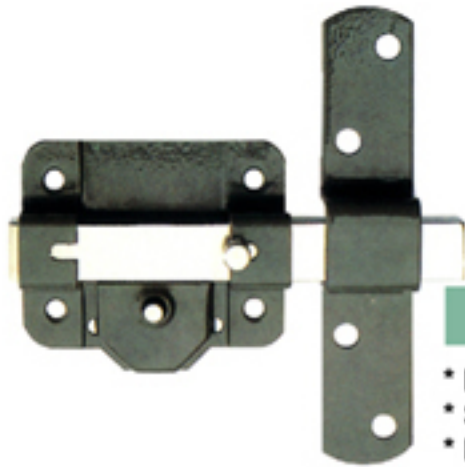

**REF:CS-137LR/90**

- \* LONG CYLINDER 50MM WITH 7 PINS
- \* STEEL BOLT CHROME PLATED 137MM
- \* BOLT OPERATED BY KEY FROM OUTSIDE AND BUTTON FROM INDSIDE
- \* 70MM CYLINDER WITH 9 PINS AVAILABLE
- \* FINISH: PAINTED, CHROME PLATED, BRASS PLATED

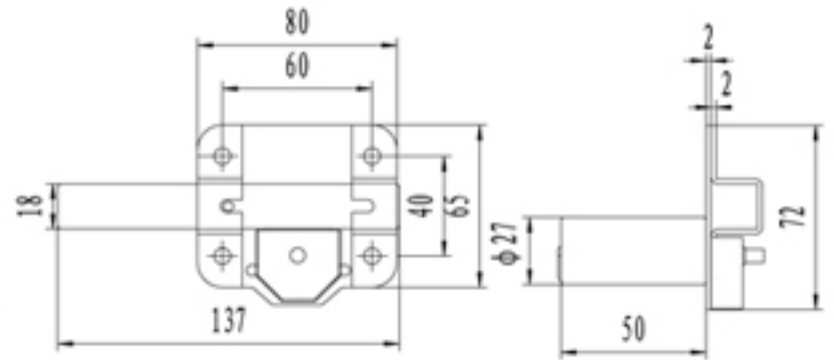

**REF CS-137LR-90**

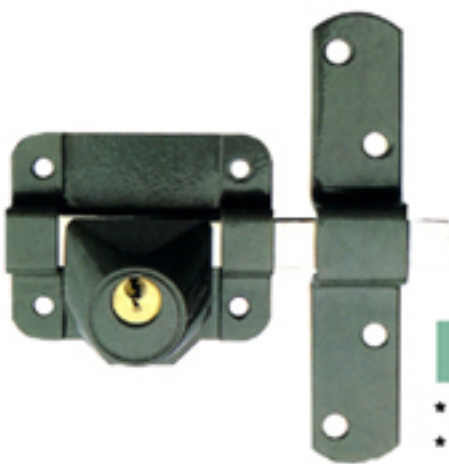

**REF:CS-140L**

- \* SINGLE CYLINDER
- \* STEEL BOLT CHROME PLATED 135MM
- \* BOLT OPERATED BY KEY FROM NDSIDE ONLY
- \* 70MM CYLINDER WITH 9 PINS AVAILABLE
- \* FINISH: PAINTED, CHROME PLATED, BRASS PLATED

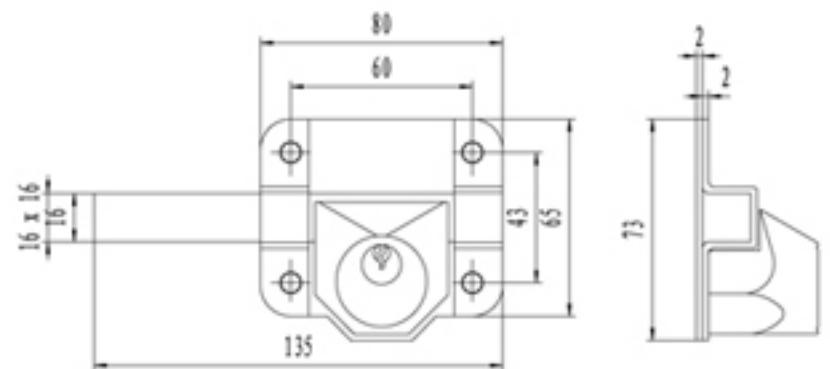

**REF CS-140L**

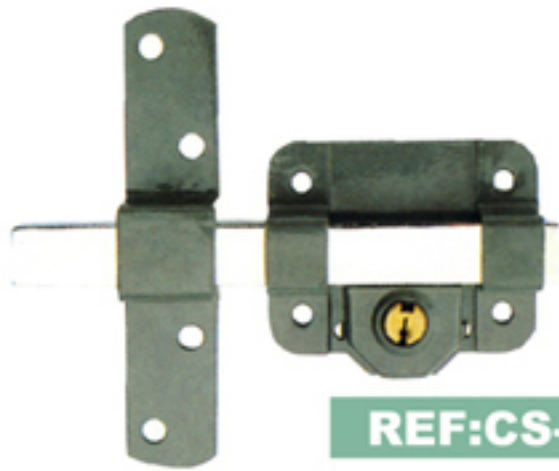

**REF:CS-160LL/90**

- \* LONG CYLINDER 50MM WITH 7 PINS
- \* STEEL BOLT CHROME PLATED 160MM
- \* BOLT OPERATED BY KEY FROM BOTH SIDES
- \* 70MM CYLINDER WITH 9 PINS AVAILABLE
- \* FINISH: PAINTED, CHROME PLATED, BRASS

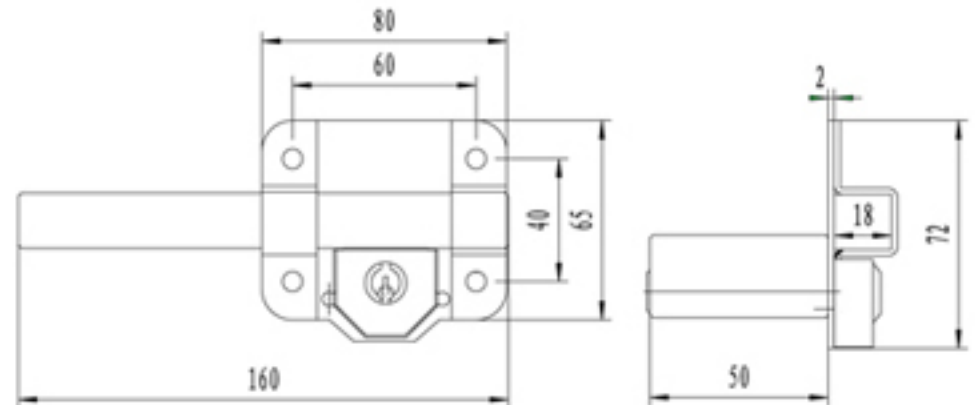

**REF CS-160LL-90**

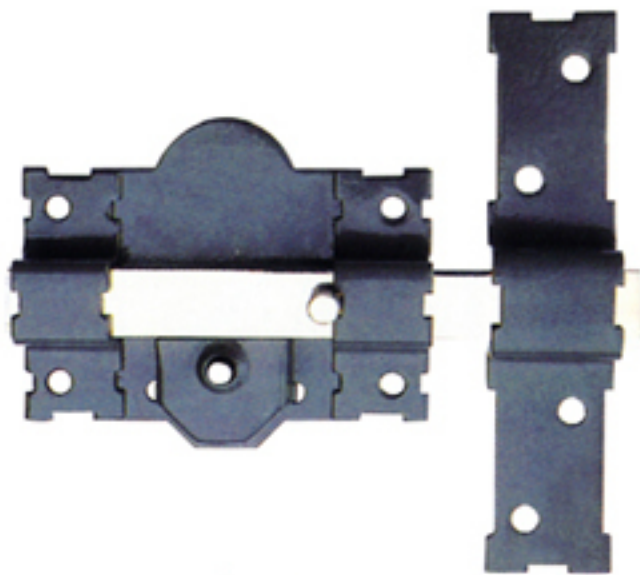

**REF:CS-160LR**

- \* LONG CYLINDER 50MM WITH 7 PINS
- \* STEEL BOLT CHROME PLATED 160MM
- \* BOLT OPERATED BY KEY FROM OUTSIDE AND BUTTON FROM INSIDE
- \* 70MM CYLINDER WITH 9 PINS AVAILABLE
- \* FINISH: PAINTED, CHROME PLATED, BRASS PLATED

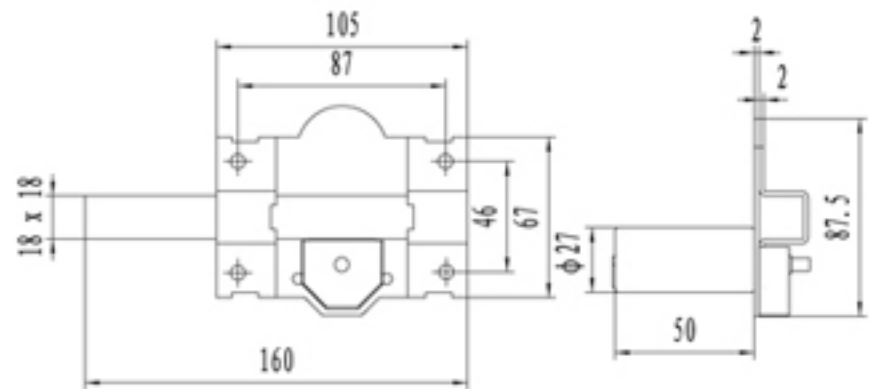

**REF CS-160LR**

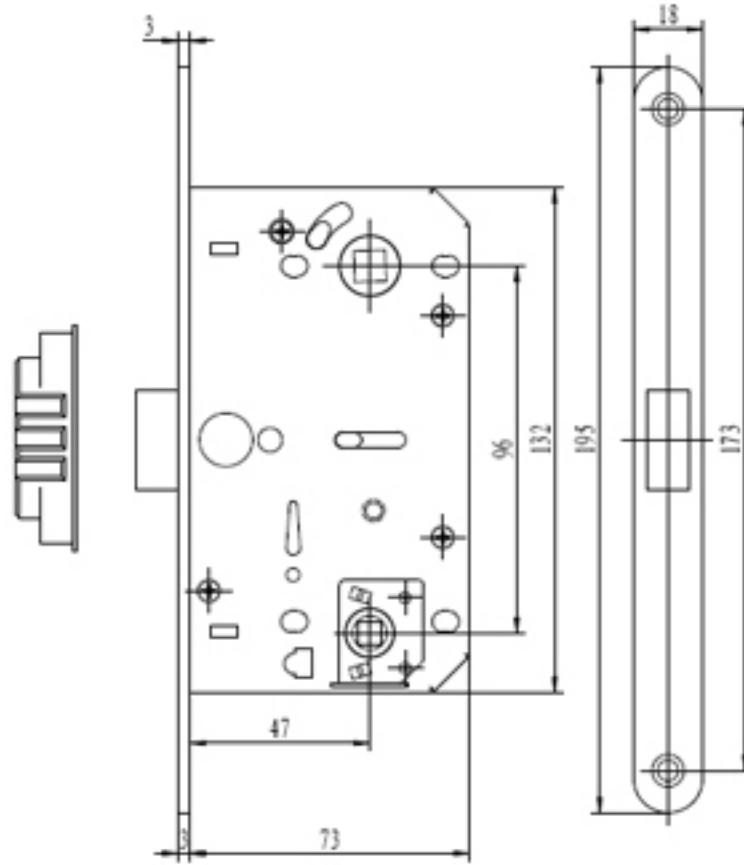

**REF 600W-M**

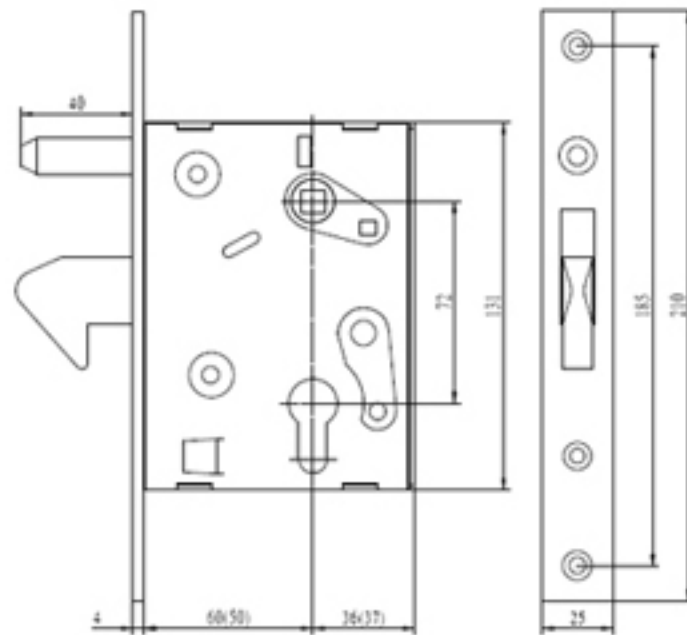

**REF C001**

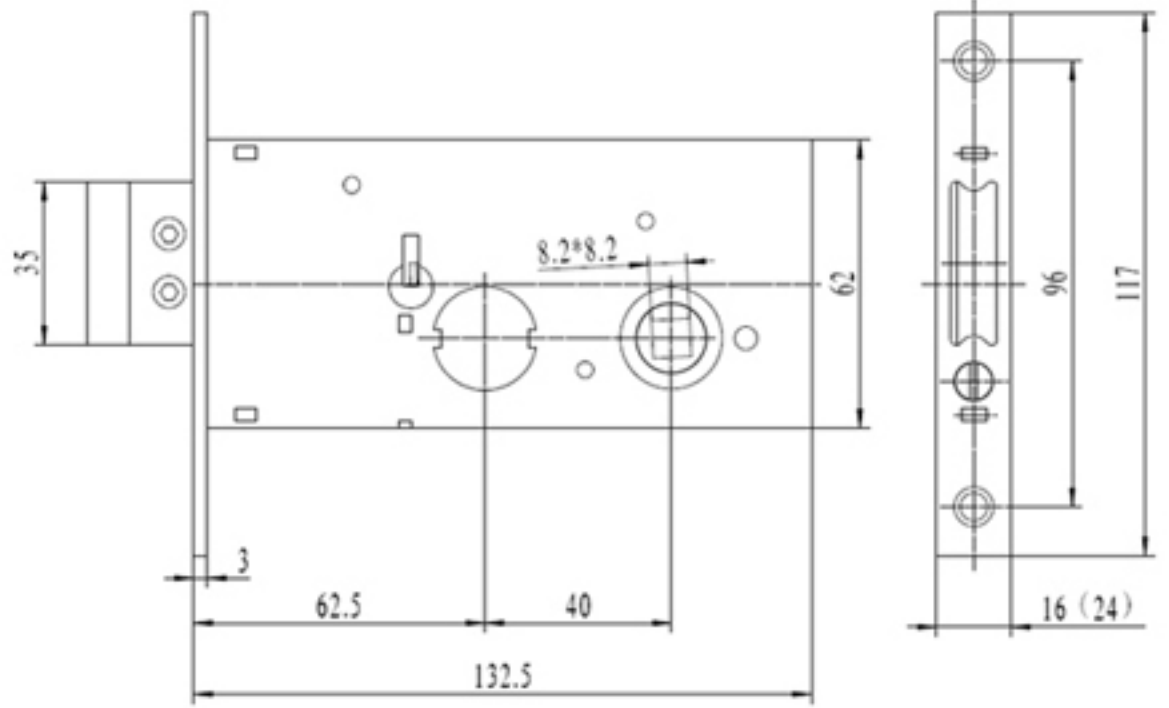
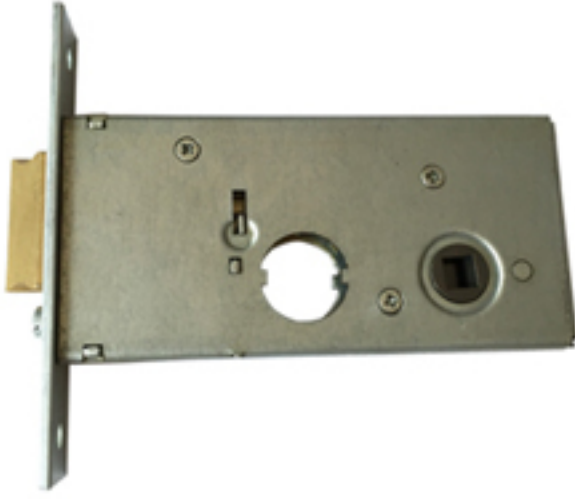

**REF T123**

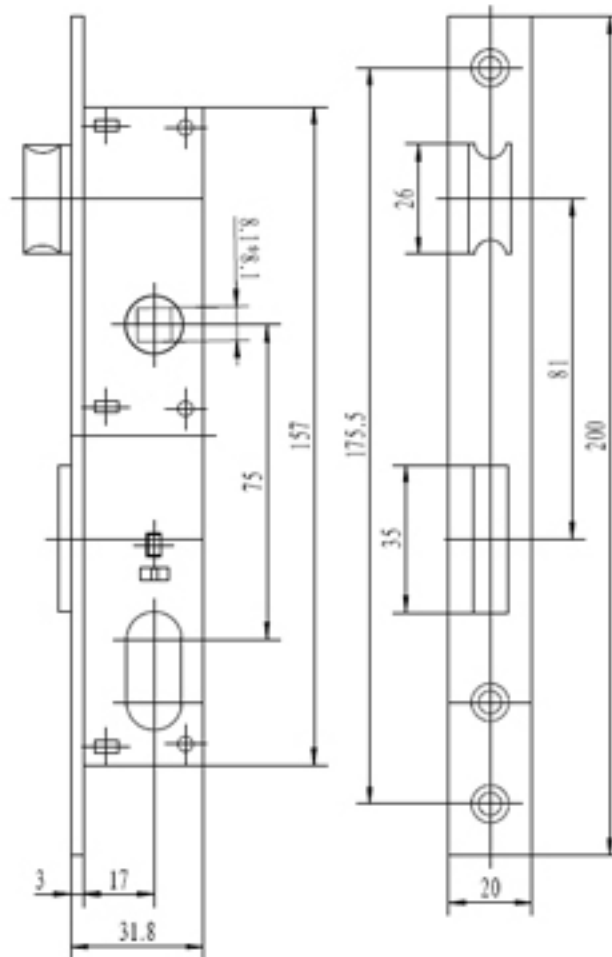

**REF 6901**